

story
price list

july2016

Prices and Specifications

Prices and specifications are subject to change without notice. All prices quoted will be FOB our factories. If applicable, sales tax will be based on ship-to destination.

Bernhardt Design reserves the right to make changes in dimensions, design and/or construction, price lists, or product literature without prior notice.

Order Entry

All orders are subject to final acceptance by Bernhardt Design in Lenoir, NC. Receipt of our acknowledgment indicates acceptance of your order subject to the terms set forth on the acknowledgment.

Bernhardt Design attempts to clarify all purchase orders. However, in the event the price list number and description on the purchase order differ, the price list number will prevail.

Changes / Cancellation

All orders in production are considered firm orders and are not subject to changes or cancellation.

Custom Design

Bernhardt Design may alter products to meet specific needs. Contact your local sales representative when a custom design is needed. Custom designs require minimum quantities, additional lead time and upcharges. A custom job number, available from your local sales representative, must be submitted with purchase orders. Orders combining custom design with standard product cannot be scheduled for production until custom items are approved.

Shipping

Bernhardt Design will ship in accordance with customer instructions whenever possible. If not specified, Bernhardt Design will exercise its best judgement in selecting a carrier. Orders in production will be shipped as scheduled and cannot be held. High quality cartoning which meets trucking and railroad specifications is standard at no extra charge.

Freight Damage and Claims

Bernhardt Design is not liable for damages that occur during transit or storage. The carrier assumes all responsibility upon acceptance of product. It is the customer's responsibility to inspect all products upon receipt and file any claims with the carrier. No product should be refused. If products are received damaged, a written exception should be made on the bill of lading and an immediate inspection be requested of the carrier. Concealed damage must be reported to the carrier within 10 business days from date of delivery. Failure to make claims shall constitute acceptance of the products and waiver any claims of defects, errors or shortages.

In the event delivery is made on a Bernhardt Design truck, the products should be carefully inspected for transit damage. If contents are damaged, the driver should be notified to call his dispatcher for immediate disposition. Concealed damage must be reported within 10 business days from date of delivery and product/packaging held for inspection by a Bernhardt Design representative.

Returns

No merchandise may be returned to Bernhardt Design without written consent in the form of a Return Authorization from our Quality Assurance Department stating reason for return and how the item will be shipped.

Unauthorized returns will be automatically refused by our receiving department as well as returns not in accordance with Bernhardt Design shipping instructions. Liability for defective merchandise shall be limited to the replacement or repair of that merchandise, and Bernhardt Design shall not be liable for other damages or losses.

Measurements and Weights

All measurements and weights are approximate and subject to change without notice.

Care and Cleaning

Finished wood surfaces should be cleaned with a soft damp cloth, wiping in the direction of the grain. Dry with a soft cloth, wiping in the grain direction. Do not use waxes or furniture polish, as these will cause a film build-up.

Wood Finishes

Bernhardt Design tables are available in standard finishes compatible with casegoods and seating finishes. However, finishes on tables may vary slightly from those on casegoods and seating due to the natural characteristics of the wood. No absolute match is implied or guaranteed.

Light Finishes

Bernhardt Design offers lighter finishes 836, 837, 840, 850 and 870. Light finishes do not hide or mask the natural characteristics of the wood. It is important that the dealer and customer understand that inherent natural characteristics of the wood will vary from piece to piece when using a light finish. Natural characteristics include the natural discolorations of the wood substance and color variations in glued up stock. These natural characteristics are not considered defects by Bernhardt Design, and therefore merchandise will not be replaced because of these natural characteristics.

Special Finishes

Special finishes, made to customer specifications and subject to factory approval, may be available at a **5% net upcharge with a \$500 net minimum**. Additional leadtime may be required for special finish items. Special finish orders will not be acknowledged until the special finish sample is approved in writing and received by Bernhardt Design Customer Service. Special finish orders are not subject to revision or cancellation after acknowledgment.

Warranty

Bernhardt Design will repair or replace, at its discretion and without charge to the original purchaser, any table product or part thereof which fails as the result of defects in material and workmanship, under single shift use and normal care, for five years from date of shipment. This warranty does not cover misuse or abuse of product, dramatic temperature changes, exposure to unusual conditions, or damages incurred by contact with seating products.

Repair or replacement of discontinued product will be at the discretion of Bernhardt Design.

Natural color changes, variations or movements in lumber or veneer products, exposure to extreme temperature changes and direct sunlight may cause color changes and/or surface damage. These are circumstances beyond the control of Bernhardt Design and are not warranty issues.

Drawer glides, drawer boxes, drawer pulls, and locking mechanisms have a Life-Time Warranty for the original purchaser. Power or communications components are warranted for one (1) year.

This warranty is the customer's exclusive remedy for product defect and does not apply to damage caused by a carrier, dealer, installer, user modification, or attachments to a product.

Bernhardt Design has the exclusive right to make the final determination of product misuse or abuse. Except as stated above, Bernhardt Design makes no express or implied warranties as to any product, and in particular, makes no warranty of merchantability or of fitness for any particular purpose. Bernhardt Design shall not be liable for any consequential or incidental damages or for commercial loss arising from any product defect. The Bernhardt Design customer is the dealer. All complaints must be resolved through the dealer from which the furniture was purchased.

To obtain warranty service the dealer must supply dated proof of purchase. This warranty gives you specific legal rights. You may also have other rights which vary from state to state.

Some states do not allow limitations on how long an implied warranty will last or the exclusion or limitation of incidental or consequential damages, so the above limitations or exclusions may not apply.

Design and Patent Rights

All of the products shown in Bernhardt Design catalogs and described in Bernhardt Design price lists are, and remain, the property of Bernhardt Design, with the sole right reserved to manufacture and to distribute. Some of the product designs shown are patented in the United States and will remain the property of Bernhardt Design. Any reproduction of the products constitutes an infringement of patented copyright laws and will be subject to prosecution.

Bernhardt Design reserves the right to make changes in dimensions, design and/or construction, price lists, or product literature without prior notice.

General Services Administration

Products available on the Bernhardt Design GSA - Federal Supply Service Contract GS-28F-7040G are noted in the product descriptions.

For information regarding GSA pricing, please contact your local Bernhardt Design sales representative or call 828 759 6337.

Send all GSA payments to:

12197 Collections Center Drive

Chicago IL 60693

Preferred Carrier Guaranteed Freight Rates

Freight charges will be applied to orders as a separate line item based on the zones listed. Rates are based on zones with a minimum for each zone. All zones are located within the Continental United States.

The freight amount is calculated on the total merchandise net price, excluding any extra discounts beyond standard net pricing. Additional freight fuel surcharges may apply. Rates are based on deliveries made Monday through Friday, 8 am until 5 pm.

All orders are shipped by Bernhardt Design company trucks or preferred carriers specified by Bernhardt Design. Dealer warehouse information, including phone number and contact name, must be specified on the purchase order.

Direct site deliveries may be requested with an additional freight cost. Requests for direct site deliveries must be made 2 weeks prior to the scheduled ship week and meet the following criteria:

- Minimum of half truckload
- Delivery site accessible by a 53' trailer
- Complete delivery site address with contact name and on-site phone number
- Labor available for unloading

Deliveries that do not meet the criteria must be directed to a receiver warehouse. If a receiver warehouse is not available, the dealer may make arrangements with their own 3rd party carrier. If a 3rd party carrier is elected, a contact name, phone number and e-mail address is required.

Weekend direct site deliveries will incur a \$500 per trailer weekend delivery fee. Weekend is defined as between 5 pm Friday and 8 am Monday.

Zone	Minimum Charge	Freight Rate	Average Service Days
1	\$80	5%	2-4 Business Days
2	\$80	6%	2-4 Business Days
3	\$90	7%	3-5 Business Days
4	\$90	8%	5-7 Business Days
5	\$90	9%	6-9 Business Days
6	\$110	10%	6-9 Business Days
7	\$110	11%	7-10 Business Days
8	\$120	12%	8-12 Business Days
9	\$120	13%	8-12 Business Days
10	\$120	15%	10-15 Business Days

Note: Average Service Days excludes ship day.

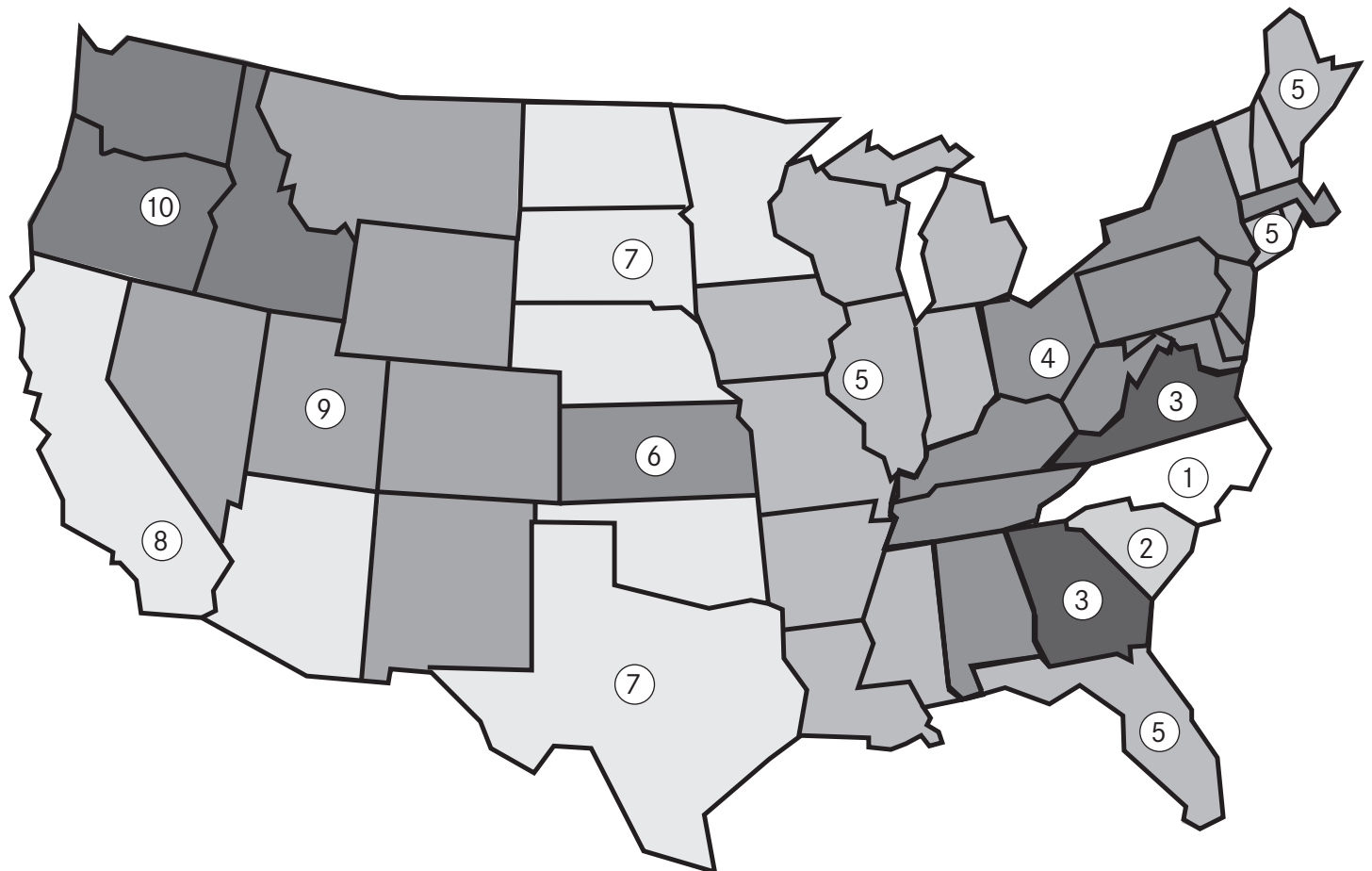

Finish Selections

A three character sku identifies the finish on each species or the laminate selection. Individual components are priced with standard finish or standard laminate.

A variety of standard laminate finishes are available. Additional laminate colors may be available but are subject to upcharges and extended lead times. The laminate option is available on components where noted as an option in the series specification code. Listed are the standard laminates.

Special finishes on veneers made to customer specifications are subject to factory approval and a 5% net upcharge with a \$500 net minimum.

Transparent stains and sealers are applied in multiple steps to enhance the beauty of the natural wood. A durable, baked-on, top-coat of conversion varnish or UV topcoat is applied to protect the product. It is recommended that felt, cork or fabric backed desk pads and accessories are used on worksurfaces to minimize wear.

When specifying light finishes such as 836, 837, 840, 850 or 870 the color and characteristic variances of both veneer and solid wood are apparent. Therefore, exact color matches are not possible.

[C] Cherry

Standard Finish	
805	840
834	841
836	861
839	

[E] Maple

Standard Finish	
837	850

[O] Oak

Standard Finish	
805	860
836	861
837	865
839	866
840	870

[G] Paldao

Standard Finish	
823	861
839	866
841	870
860	

[W] Walnut

Standard Finish	
823	861
839	866
841	870
860	

[F] Plain/Abstract Laminate

Standard Plain/Abstract	
601	Solid White, Nevamar S-7004T, with Solid White Edge
604	Winter Gray Matrix, Nevamar MR-6005T, with Platinum Edge
605	Straw Matrix, Nevamar MR-2006T, with Platinum Edge
611	Brite White, Formica 459-58, with Designer White Edge
644	Stop Red, Formica 839-58, with Spectrum Red Edge
645	Smoky White, Nevamar S7027T, with Frosty White Edge
646	Cordial Gray, Nevamar S6024T, with Featherstone Edge
660	Folkstone, Formica 927-58, with Fashion Grey Edge
661	Fog, Formica 961-58, with Dove Grey Edge
662	Black, Formica 909-58, with Black Edge
694	Almond, Nevamar S2037T, with Almond Edge
695	Tawny White, Pionite SW812, with Antique White Edge
696	Taupe, Pionite ST606, with Khaki Brown Edge
697	Sandcastle, Nevamar S2093T, with Pepperdust Edge

[W] Woodgrain Laminate

Standard Woodgrain	
670	Gunstock Savoy Walnut, Pionite WW971, with Columbian Walnut Edge
685	Grand Isle Maple, Nevamar W8371T, with African Limba Edge
686	Valencia Teak, Nevamar WT0003PV, with Shadow Oak Edge
687	Sovereign Cherry, Nevamar W8325T, with Wild Cherry Edge
688	Clear Maple, Nevamar WM8340T, with Natural Maple Edge
689	Kingsley, Pionite WW011, with Kingsley Edge
690	Cocoa Maple, Formica 7739-58, with Cocoa Maple Edge
691	Prestige Walnut, Formica 6209-43, with Shadow Oak Edge
692	Select Cherry, Formica 7759-43, with Select Cherry Edge
693	Northern Oak, Formica 7152-58, with Clear Maple Edge

Story Base



The Story table is available with a fixed or folding top. The 4-star polished aluminum base has adjustable levelers with 1/2" leveling range.

The Story base is available in a table height as well as a bar height. The base is appropriate for round or square tops ranging from 24" to 42" as well as a 30" x 24" rectangular top.

The Story conference table collection is available upon request with certifications for level® 1, GREENGUARD and FSC Chain-of-Custody. Requests must be made in writing in advance of or during the quoting process as upcharges may apply. For complete information regarding the level 1, GREENGUARD and FSC certifications for Story, please contact bgreen@bernhardt.com.

Approved for GSA Contract GS-28F-7040G.



Detail View of Story Leg

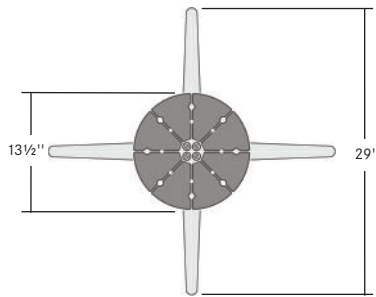

Plan View of Story Base

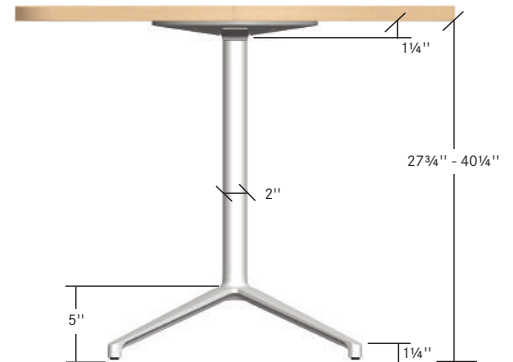

Elevation View of Story Base

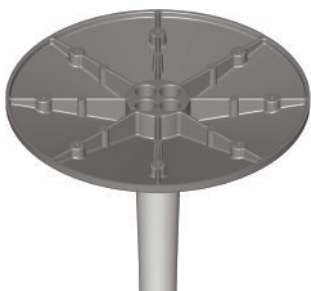

Fixed Base

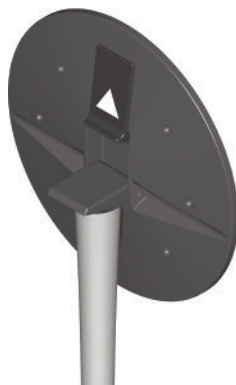

Folding Base with Latch Mechanism

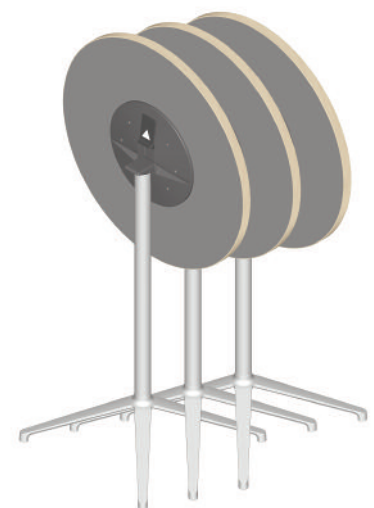





Nested Tables



story bases

available in fixed or folding base in two heights
 standard table height and bar height
 approved for GSA Contract GS-28F-7040G
 Level 1 Certified
 GREENGUARD Certified

description	sku	w	d	h	weight	specifications	price
 table height fixed	5FX	29	29	27¾	35	use with 24-42" w tops	\$ 497
 table height folding	5FD	29	29	27¾	35	use with 24-42" w tops	564
 bar height fixed	6FX	29	29	40¼	40	use with 24-30" w tops	528
 bar height folding	6FD	29	29	40¼	40	use with 24-30" w tops	595

specification codes

series

story

V

sku

veneer

none

X

style

none

X

base

polished aluminum

6

finish

X X X

Story Tops



Detail view of the Story top with the folding base.

Story tops are specifically constructed to accommodate the Story table base.

The Story table is available with round or square tops ranging from 24" to 42" and a 30" x 24" rectangular top with a flat or bevel edge.

The Story conference table collection is available upon request with certifications for level® 1, GREENGUARD and FSC Chain-of-Custody. Requests must be made in writing in advance of or during the quoting process as upcharges may apply. For complete information regarding the level 1, GREENGUARD and FSC certifications for Story, please contact bgreen@bernhardt.com.

Veneer Selections

Laminates

- F Plain/Abstract Laminate
- W Woodgrain Laminate

A variety of standard laminate finishes are available with vinyl edge bands specifically formulated to correspond to standard laminates. See finish selections in the appendix for standard laminates and edge bands.

Veneer

C Oak Rift Cut	E Maple Flat Cut	J Cherry Flat Cut	9 Walnut Flat Cut	G Paldao Quarter Cut

Edge Group A

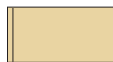

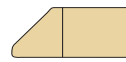

F Flat - 1 1/4"

Edge Group B

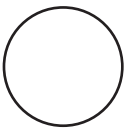

W Bevel - 1"

specification codes	series	sku	veneer	edge	base	finish
	Q top		F plain/abstract laminate W woodgrain laminate J cherry E maple C oak 9 walnut G paldao	laminate F 1 1/4" flat group A F 1 1/4" flat group B W 1" bevel	V story base	see appendix
	Q				V	

	story tops			laminate		cherry maple oak walnut		paldao	
				plain abstract	woodgrain	edge group A	edge group B	edge group A	edge group B
sku	w	d	specifications						
 <p>tops sold separately order bases separately approved for GSA Contract GS-28F-7040G Level 1 Certified GREENGUARD Certified</p>									
round top									
	YAY	24	24	\$ 465	\$ 489	\$ 846	\$ 990	\$ 982	\$ 1125
	YAL	27	27	495	520	909	1063	1055	1210
	YAX	30	30	527	554	1041	1218	1208	1385
	YAW	36	36	558	587	1171	1370	1358	1557
	YAV	42	42	742	779	1299	1521	1507	1729
square top									
	YBY	24	24	465	489	846	990	982	1125
	YBL	27	27	495	520	909	1063	1055	1210
	YBX	30	30	527	554	1041	1218	1208	1385
	YBW	36	36	558	587	1171	1370	1358	1557
rectangular top									
	YCD	30	24	528	555	1041	1218	1208	1385

specification codes	series	sku	veneer	edge	base	finish
	Q top		F plain/abstract laminate W woodgrain laminate J cherry E maple C oak O walnut G paldao	laminate F 1/4" flat group A F 1/4" flat group B W 1" bevel	V story base	see appendix
	Q				V	