

itinerary  
price list

march 2018

**Sales and Service Policy**

Guidelines detailing the operating policies and procedures of Bernhardt Design are provided in the Sales and Service Policy available online at <http://www.bernhardtdesign.com/sales-and-service-policy>.

**Prices and Specifications**

Prices and specifications are subject to change without notice. All prices quoted will be FOB our factories. If applicable, sales tax will be based on ship-to destination.

Bernhardt Design reserves the right to make changes in dimensions, construction, price lists, or product literature without prior notice.

**Order Entry**

All orders are subject to final acceptance by Bernhardt Design in Lenoir, NC. Receipt of our acknowledgment indicates acceptance of your order subject to the terms set forth on the acknowledgment. Bernhardt Design attempts to clarify all purchase orders. However, in the event the price list number and description on the purchase order differ, the price list number will prevail.

**Changes / Cancellation**

All orders in production are considered firm orders and are not subject to changes or cancellation.

**Custom Design**

Bernhardt Design may alter products to meet specific needs. Contact your local sales representative when a custom design is needed. Custom designs require minimum quantities, additional lead time, and upcharges.

A custom job number, available from your local sales representative, must be submitted with purchase orders. Orders combining custom design with standard product cannot be scheduled for production until custom items are approved.

Custom design orders are not subject to revision or cancellation after acknowledgment.

**Shipping**

Bernhardt Design will ship in accordance with customer instructions whenever possible. If not specified, Bernhardt Design will exercise its best judgement in selecting a carrier. Orders in production will be shipped as scheduled and cannot be held.

High quality cartoning meeting trucking and railroad specifications is standard at no extra charge. Some items may be blanket wrapped for shipment.

**Freight Damage and Claims**

Bernhardt Design is not liable for damages that occur during transit or storage. The carrier assumes all responsibility upon acceptance of product. It is the customer's responsibility to inspect all products upon receipt and file any claims with the carrier. No product should be refused.

If products are received damaged, a written exception should be made on the bill of lading and an immediate inspection be requested of the carrier. Concealed damage must be reported to the carrier within 10 business days from date of delivery. Failure to make claims shall constitute acceptance of the products and waiver any claims of defects, errors or shortages.

In the event delivery is made on a Bernhardt Design truck, the products should be carefully inspected for transit damage. If contents are damaged, the driver should be notified to call his dispatcher for immediate disposition. Concealed damage must be reported within 10 business days from date of delivery and product/packaging held for inspection by a Bernhardt Design representative.

Replacements for product damaged in shipment or storage will be manufactured upon receipt of a purchase order.

**Returns**

No merchandise may be returned to Bernhardt Design without written consent in the form of a Return Authorization from our Quality Assurance Department stating why the item is being returned and how the item will be shipped.

Unauthorized returns will be automatically refused by our receiving department as well as returns not in accordance with Bernhardt Design shipping instructions. Liability for defective merchandise shall be limited to the replacement or repair of that merchandise, and Bernhardt Design shall not be liable for other damages or losses.

**Measurements and Weights**

All measurements and weights are approximate and subject to change without notice.

**Care and Cleaning**

Finished wood surfaces should be cleaned with a soft damp cloth, wiping in the direction of the grain. Furniture should be buffed dry immediately with a soft cloth.

**Wood Finishes**

Bernhardt Design tables are available in finishes that are compatible with casegoods and seating finishes. However, finishes on tables may vary slightly from those on casegoods and seating due to the natural characteristics of the wood. No absolute match is implied or guaranteed.

**Light Finishes**

Bernhardt Design offers lighter finishes 836, 837, 840, 850, and 870 on certain veneers. Light finishes do not hide or mask the natural characteristics of the wood. Therefore, inherent natural characteristics of the wood will vary from piece to piece when using a light finish. Natural characteristics include the natural discolorations of the wood substance and color variations in glued up stock. These natural characteristics are not considered defects by Bernhardt Design, and therefore merchandise will not be replaced.

**Special Finishes**

Special finishes, made to customer specifications and subject to factory approval, may be available at a **5% net upcharge with a \$500 net minimum**. Additional leadtime may be required for special finish items.

Special finish orders will not be acknowledged until the special finish sample is approved in writing and received by Bernhardt Design Customer Service. Special finish orders are not subject to revision or cancellation after acknowledgment.

**Warranty**

Bernhardt Design will repair or replace, at its discretion, any table product or part thereof which fails as the result of defects in material and workmanship, under single shift use and normal care for five years. This warranty shall apply only to the original purchaser.

This warranty does not cover normal wear and tear, misuse or abuse of product, dramatic temperature changes, exposure to unusual conditions or damages incurred by contact with seating products, casegoods or other surfaces.

Natural color changes, variations or movements in lumber or veneer products, exposure to extreme temperature changes and direct sunlight may cause color changes and/or surface damage. These are circumstances beyond the control of Bernhardt Design and are not warranty issues.

Repair or replacement of discontinued product will be at the discretion of Bernhardt Design.

This warranty is the customer's exclusive remedy for product defect and does not apply to damage caused by a freight carrier, dealer, installer, user modification, attachments to a product, or any third party. Bernhardt Design has the exclusive right to make the final determination of product misuse or abuse.

Except as stated above, Bernhardt Design makes no express or implied warranties as to any product, and in particular, makes no warranty of merchantability or of fitness for any particular purpose.

Bernhardt Design shall not be liable for any consequential or incidental damages or for commercial loss arising from any product defect.

**Operational Parts Warranty**

Drawer glides, drawer boxes, drawer pulls, and lock mechanisms have a Life-Time Warranty for original purchaser. Power and communication components are warranted for one year.

**Design and Patent Rights**

All of the products shown in Bernhardt Design catalogs and described in Bernhardt Design price lists are, and remain, the property of Bernhardt Design, with the sole right reserved to manufacture and to distribute.

Some of the product designs shown are patented in the United States and will remain the property of Bernhardt Design. Any reproduction of the products constitutes an infringement of patented copyright laws and will be subject to prosecution.

Bernhardt Design reserves the right to make changes in dimensions, design and/or construction, price lists, or product literature without prior notice.

**General Services Administration**

Products available on the Bernhardt Design GSA - Federal Supply Service Contract GS-27F-010GA are noted in the overview section of the product descriptions.

For information regarding GSA pricing, please contact your local Bernhardt Design sales representative or call 828.759.6337.

Send all GSA payments to:  
12197 Collections Center Drive  
Chicago IL 60693

**Preferred Carrier Guaranteed Freight Rates**

Freight charges will be applied to orders as a separate line item based on the zones listed. Rates are based on zones with a minimum for each zone. All zones are located within the Continental United States.

The freight amount is calculated on the total merchandise net price, excluding any extra discounts beyond standard net pricing. Additional freight fuel surcharges may apply. Rates are based on deliveries made Monday through Friday, 8 am until 5 pm.

All orders are shipped by Bernhardt Design company trucks or preferred carriers specified by Bernhardt Design. Dealer warehouse information, including phone number and contact name, must be specified on the purchase order.

Direct site deliveries may be requested with an additional freight cost. Requests for direct site deliveries must be made 2 weeks prior to the scheduled ship week and meet the following criteria:

- Minimum of half truckload
- Delivery site accessible by a 53' trailer
- Complete delivery site address with contact name and on-site phone number
- Labor available for unloading

Deliveries that do not meet the criteria must be directed to a receiver warehouse. If a receiver warehouse is not available, the dealer may make arrangements with their own 3rd party carrier. If a 3rd party carrier is elected, a contact name, phone number and e-mail address is required.

Weekend direct site deliveries will incur a \$500 per trailer weekend delivery fee. Weekend is defined as between 5 pm Friday and 8 am Monday.

Zone	Minimum Charge	Freight Rate	Average Service Days
1	\$80	5%	2-4 Business Days
2	\$80	6%	2-4 Business Days
3	\$90	7%	3-5 Business Days
4	\$90	8%	5-7 Business Days
5	\$90	9%	6-9 Business Days
6	\$110	10%	6-9 Business Days
7	\$110	11%	7-10 Business Days
8	\$120	12%	8-12 Business Days
9	\$120	13%	8-12 Business Days
10	\$120	15%	10-15 Business Days

**Note:** Average Service Days excludes ship day.

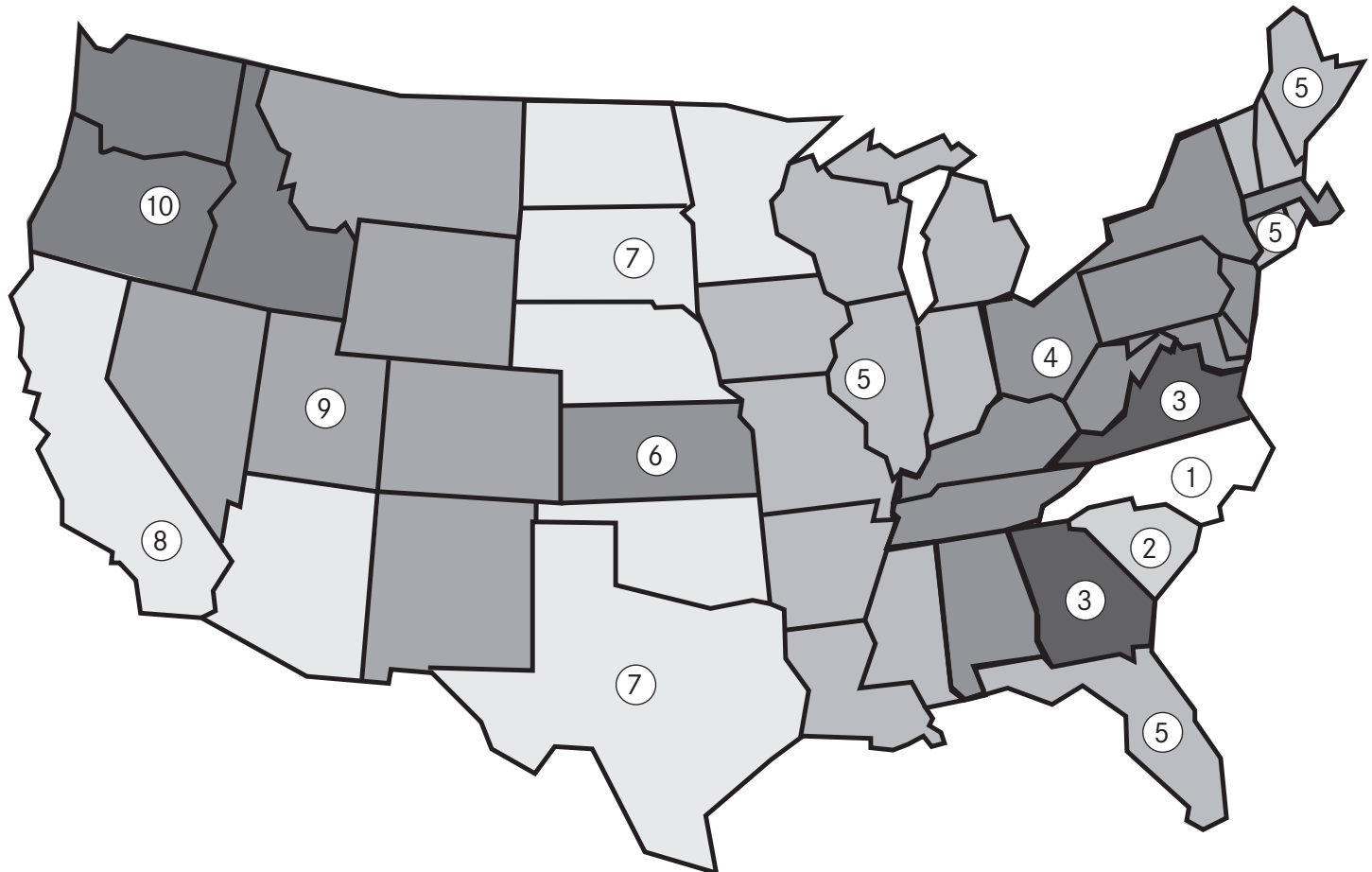

### Laminate Selections

A three character sku identifies each laminate selection as well as the standard finish offered. Individual components are priced with standard finish on standard laminate.

Additional colors may be available but are subject to upcharges and extended lead times. The laminate option is available on components where noted as an option in the material specification code.

All laminate tops will have a 3mm matching edge band.

#### PLL Solid Laminate

Standard Solid

- 671 Designer White, Wilsonart D354-60 Matte Finish
- 672 Frosty White, Wilsonart 1573-60 Matte Finish
- 673 Fashion Grey, Wilsonart D381-60 Matte Finish
- 674 North Sea, Wilsonart D90-60 Matte Finish
- 675 Black, Wilsonart 1595-60 Matte Finish

#### WGL Woodgrain Laminate

Standard Woodgrain

- 678 New Age Oak, Wilsonart 7938-16 Causal Rustic Finish
- 679 Brazilwood, Wilsonart 7946-38 Matte Finish
- 680 Walnut Heights, Wilsonart 7965K-12 Soft Grain Finish
- 681 Studio Teak, Wilsonart 7960-16 Causal Rustic Finish
- 682 Asian Night, Wilsonart 7949-16 Causal Rustic Finish
- 683 Portico Teak (Grey), Wilsonart 8210K-28 Gloss Line Finish

### Edge Style Selections

#### Laminates and Veneers

FL 1 1/4" Flat

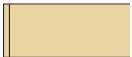

### Base Selections

#### CA Casters

- 3" Non-Marring Urethane Wheels
- 2 Locking Casters



#### GL Glides

- Leveling
- 3/4" Height Adjustment Range



### Veneer Selections

A three character sku identifies each species as well as the standard finish offered. Individual components are priced with standard finish. Special finishes on veneers made to customer specifications are subject to factory approval and a 5% net upcharge with a \$500 net minimum.

Transparent stains and sealers are applied in multiple steps to enhance the beauty of the natural wood. A durable, baked-on, top-coat of conversion varnish or UV topcoat is applied to protect the product. It is recommended that felt, cork or fabric backed desk pads and accessories are used on worksurfaces to minimize wear.

When specifying light finishes such as 836, 837, 840, 850 or 870, the color and characteristic variances of both veneer and solid wood are apparent. Therefore, exact color matches are not possible.

#### CHY Cherry

Flat Cut

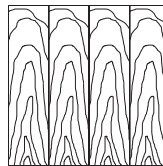

- Standard Finish
- 805 840
  - 834 841
  - 836 861
  - 839

#### MPL Maple

Flat Cut

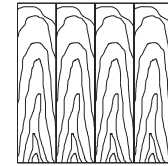

- Standard Finish
- 837
  - 850

#### WLT Walnut

Flat Cut

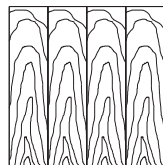

- Standard Finish
- 823 861
  - 839 866
  - 841 870
  - 860

#### OAK Oak

Rift Cut

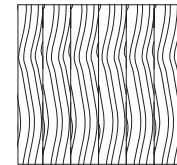

- Standard Finish
- 805 860
  - 836 861
  - 837 865
  - 839 866
  - 840 870

**Itinerary Tables**

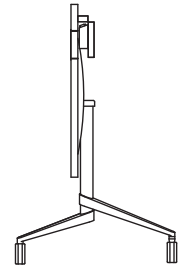
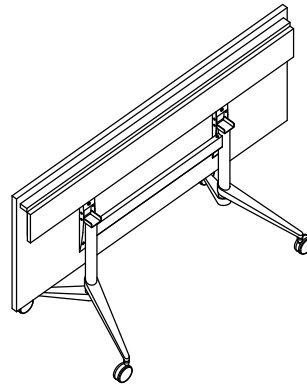

Folding table with modesty panel with 9" grommet and YEC electrical module

Designed for use in flexible environments requiring reconfigurations and easy storage. Available with a 1 1/4" thick top in wood veneer or a laminate top with vinyl edge band. See veneer and laminate options. Grain will run the length of the table in veneer applications. Tops are pre-machined for ganging brackets and corner top attachment brackets. Communication grommets are available for wire management. Grommet placement must be specified when ordering table. See specification information and grommet location codes. Shipped assembled.

Two base options are available. The mobile base option utilizes four non-leveling 80mm dual wheel casters and two of the casters are locking. The fixed base option uses four leveling glides with black detail. The glides have a polished aluminum finish to match the base.

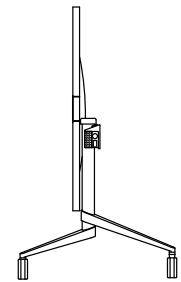
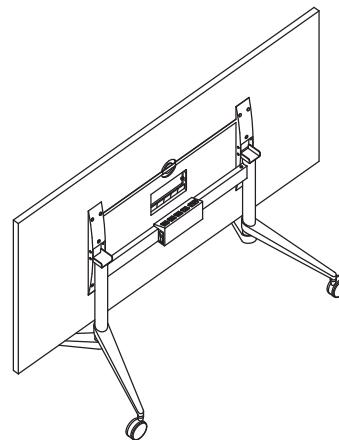

Folding table with center 9" grommet and YEB crossbar electrical module

A 1 1/4" x 8" h modesty panel on the folding training table conceals electrical and power components when extended. When stored, the panel folds allowing the table to nest tightly in storage. Both sides of the modesty panel are finished in the surface material of the top specified. The YEC electrical module has been designed specifically for power management with the folding modesty panel training table. See power module options.

Two options are available for providing power to folding conference tables without a modesty panel. The YEB crossbar electrical module is used with the 9" communication grommet and attaches to the center crossbar in one of three locations on the bar. The E8E power module is self-contained and worksurface mounted. See power module options.

Itinerary folding tables are designed to nest for compact storage. A handle underneath the table top when turned in a clockwise motion, releases the table top to fold. When in the folded position, the tables slide together to nest with each table occupying approximately 6" of incremental storage space. See top and side view illustrations.

Itinerary is BIFMA Level 2, GREENGUARD and FSC® C012937 certified. Visit the product page at [Bernhardtdesign.com](http://Bernhardtdesign.com) for BIFMA Level 2 and GREENGUARD certifications. FSC® C012937 Chain of Custody certification is available by submitting a request in writing before or during the quoting process to be printed on acknowledgments and invoices. For complete information regarding the Level 2, GREENGUARD and FSC certifications, please contact [bgreen@bernhardt.com](mailto:bgreen@bernhardt.com).

Approved for GSA Contract GS-275-010GA.

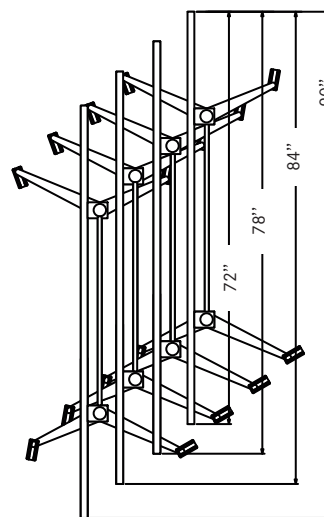

Nesting Configuration: Top view of four tables nested. Approximate dimensions based on 72" table top.

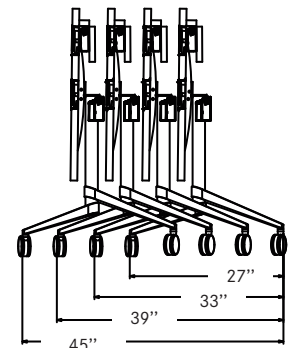

Nesting Configuration: Side view of four tables nested. Approximate dimensions.

**Communication Grommets**

The communication grommet is installed into a worksurface to allow the passage of wires through the surface to a power or communication source beneath. The units easily open to provide wire passage. Two options of 9" communication grommets are available: an anodized aluminum grommet with brushed aluminum finish, and a cast aluminum grommet with wood veneer or laminate panels that match the finish on the table top. The 9" communication grommet may be used in conjunction with power modules on tables 30"d or larger.

The position along the length of the table must be specified on the purchase order when ordering the top. Grommets cannot be changed or added after an order is acknowledged and entered into production.

**Communication Grommet  
Brushed Aluminum Finish**

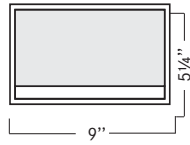

**VFA - Brushed Aluminum Finish**

**Communication Grommet  
Wood Veneer or Laminate Panel**

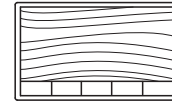

**VFD - Veneer Finish Grain Long**

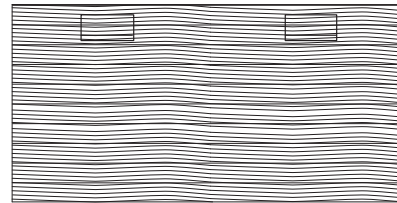

**Veneer grain runs the length of the top (long direction).**

**Grommet Location Codes**

**E8E Module-- Use with All Top Sizes**



**HSA** grommet location  
Use with all top sizes  
Specify E8E module separately

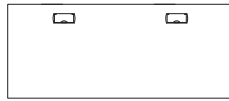

**HSB** grommet location  
Use with all top sizes  
Specify E8E modules separately

**VFA or VFD Grommets - Use with Tops 30" - 40"d**



**HAB** grommet location  
Use with tops 30" - 40"d  
Specify VFA or VFD grommets separately  
Specify modesty panel  
Specify YEC electrical module

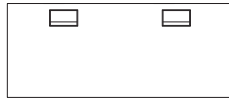

**HAC** grommet location  
Use with tops 30" - 40"d  
Specify VFA or VFD grommets separately  
Specify modesty panel  
Specify YEC electrical module



**SAA** grommet location  
Use with tops 30" - 40"d  
Specify VFA or VFD grommets separately

**Power Modules**

The power module is an interconnection device which works in conjunction with the 9" communication grommet and integrates convenient grounded receptacles and communication data modules.

The YEB crossbar electrical module, designed for mounting on the crossbar of the folding conference table 30"d and larger, has four grounded outlets – 120 volt, 60 Hz; 15 amp – with one outlet rotated for transformer plugs, an integrated switch and breaker and a 9' cord with a three wire grounded plug. Also included: two Amp® RJ45 Cat5e jacks on the top with two RJ45 extension jacks on the side. UL Listed, CSA Approved. Polished chrome faceplate with brushed stainless steel housing box and data modules.

The YEC folding modesty panel electrical module was designed specifically for power management with the folding modesty panel training table 30"d and larger. Includes four rounded outlets – 120 volt, 60 Hz, 15amp – with one outlet rotated for transformer plugs, an integrated switch and breaker; 9' cord with a three-wire grounded plug. Also included: two Amp® RJ45 Cat5e extension jacks on the top and side. UL Listed, CSA Approved. Brushed stainless steel housing box and data modules with a black mounting plate.

A self-contained, worksurface mounted, power module features two 110 volt outlets with a 6' cord with a three-wire grounded plug integrated with two Amp® RJ45 Cat5e jacks with 9' cable and plug. UL Listed, CSA Approved. Matte black plastic. The E8E is the only power module for use on a 27"d table.

**Crossbar Electrical Module**

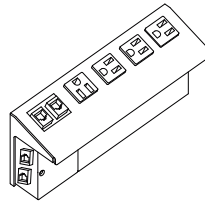

**YEB**  
For use with SAA Grommet Locations

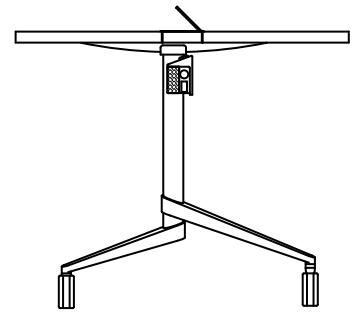

**Folding Modesty Panel Electrical Module**

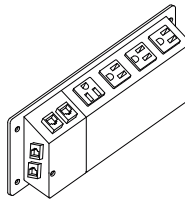

**YEC**  
For use with the HAB and HAC Grommet Locations and a Modesty Panel

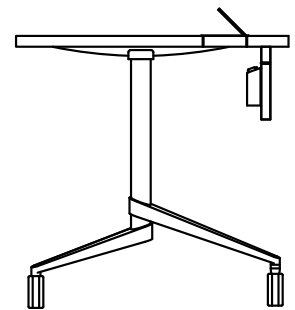

**Worksurface Power Module**

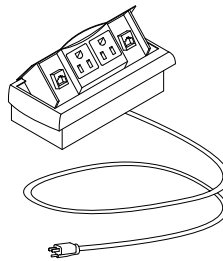

**E8E**

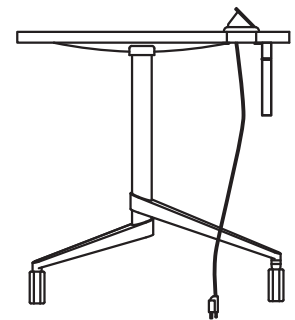



itinerary tables

polished aluminum glides and casters  
shipped assembled



folding rectangular training table

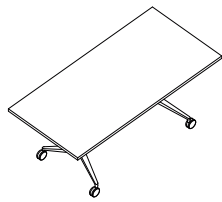

sku	w	d	h	weight	specifications	solid or woodgrain laminate	cherry maple oak walnut
Y3L	60	27	29	95	use with E8E power module	\$ 3122	\$ 3339
Y3M	66	27	29	100	use with E8E power module	3251	3479
Y3N	72	27	29	105	use with E8E power module	3399	3635
Y3P	78	27	29	110	use with E8E power module	3683	3935
Y3A	60	30	29	105		3122	3339
Y3B	66	30	29	110		3251	3479
Y3C	72	30	29	115		3399	3635
Y3D	78	30	29	120		3683	3935
Y3E	84	30	29	130		3780	4043
Y3F	72	36	29	130		3499	3740
Y3G	78	36	29	140		3780	4043
Y3H	84	36	29	150		3915	4184
Y3J	72	40	29	145		3671	3924
Y3K	78	40	29	155		3921	4192

folding trapezoid shape training table

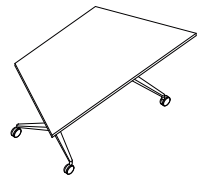

Y4B	60	27	29	90	42" end, use E8E power module	3210	3432
Y4D	72	27	29	95	48" end, use E8E power module	3500	3741
Y4A	60	30	29	100	42" end	3210	3432
Y4C	72	30	29	110	48" end	3500	3741
Y4K	60	36	29	110	42" end	3341	3574
Y4F	72	36	29	125	48" end	3643	3893

specification codes example: TYS-SKU-FLCAHSA

series	sku	edge	base style	grommet location
itinerary		FL 1/4" flat	CA casters GL glides	000 none see page 7 for location codes
T   Y   S   -	-	F   L		

material + finish code example: WLT 839

material	finish
PLL solid laminate	see page 5
WGL woodgrain laminate	
CHY cherry	
MPL maple	
OAK oak	
WLT walnut	

**itinerary table with modesty panel**



folding modesty panel conceals power management accessories  
 1 1/4" x 8" h modesty panel  
 polished aluminum glides and casters  
 material code is for both top and modesty panel  
 shipped assembled

**folding rectangular training table**

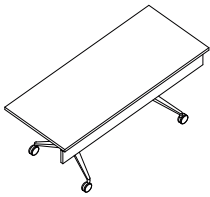

sku	w	d	h	weight	specifications	solid or woodgrain laminate	cherry maple oak walnut
Y2A	60	27	29	110	use with E8E power module	\$ 3919	\$ 4414
Y2B	66	27	29	115	use with E8E power module	4042	4623
Y2C	72	27	29	125	use with E8E power module	4172	4783
Y2D	78	27	29	130	use with E8E power module	4438	5086
Y2E	60	30	29	115		3919	4487
Y2F	66	30	29	125		4042	4623
Y2G	72	30	29	130		4172	4783
Y2H	78	30	29	140		4438	5086

**specification codes example: TYS-SKU-FLCAHSA**

series	sku	edge	base style	grommet location
itinerary		FL 1 1/4" flat	CA casters GL glides	000 none see page 7 for location codes
T   Y   S   -	-	F   L		

**material + finish code example: WLT 839**

material	finish
PLL solid laminate WGL woodgrain laminate CHY cherry MPL maple OAK oak WLT walnut	see page 5

corner worksurface

mounting hardware included  
quarter round shape



quarter round shape  
corner top

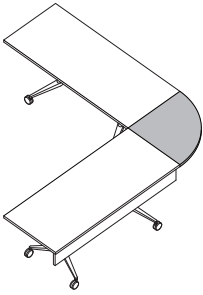

sku	w	d	h	weight	specifications	solid or woodgrain laminate	cherry maple oak walnut
YFA	27	27	1¼	30	1¼" thick top	\$ 1082	\$ 1206
YFB	30	30	1¼	35	1¼" thick top	1195	1330
YFC	36	36	1¼	50	1¼" thick top	1313	1463
YFD	40	40	1¼	65	1¼" thick top	1406	1567



specification codes example: TYS-SKU-FL

series	sku	edge
itinerary		FL 1¼" flat
T   Y   S   -		F   L

material + finish code example: WLT 839

material	finish
PLL solid laminate	see page 5
WGL woodgrain laminate	
CHY cherry	
MPL maple	
OAK oak	
WLT walnut	

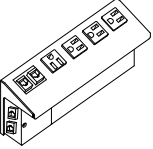
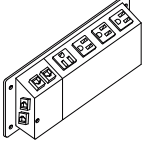

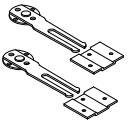
description	sku	w	d	h	weight	specifications	price
 <p><b>crossbar electrical module</b></p> <p>specify for folding table application with SAA grommet location polished chrome faceplate in brushed stainless steel housing four grounded outlets with one rotated for transformer plugs two Amp® RJ45 Cat5e data jacks on the top two Amp® RJ45 Cat5e extension jacks on the side approved for GSA contract GS-27F-010GA</p>	YEB	9	2¾	4	3	9' cord with a three-wire grounded plug	\$ 637
 <p><b>folding modesty panel electrical module</b></p> <p>specify for folding modesty panel applications with HAB and HAC grommet locations and a modesty panel black powdercoat faceplate in brushed stainless steel housing four grounded outlets with one rotated for transformer plugs two Amp® RJ45 Cat5e extension jacks on the top and side approved for GSA contract GS-27F-010GA</p>	YEC	9	1½	4	3	9' cord with a three-wire grounded plug	566
 <p><b>wire guide</b></p> <p>for folding table leg snaps around table leg clear polycarbonate 2 per package approved for GSA contract GS-27F-010GA</p>	YC2	2¾	2½	5⁄8	1		15
 <p><b>cable clamp</b></p> <p>for underside of table 4 clips per package gray finish</p>	E5E	1	1	7⁄8	1		46
 <p><b>ganging brackets</b></p> <p>two sets for ganging two tables field installed</p>	E8D	6	2¾	¼	3	42" end, use E8E power module	130

specification codes example: ACS-SKU

series	sku
accessories	
A   C   S   -	