

powerbar
price list

march 2018

Sales and Service Policy

Guidelines detailing the operating policies and procedures of Bernhardt Design are provided in the Sales and Service Policy available online at <http://www.bernhardtdesign.com/sales-and-service-policy>.

Prices and Specifications

Prices and specifications are subject to change without notice. All prices quoted will be FOB our factories. If applicable, sales tax will be based on ship-to destination.

Bernhardt Design reserves the right to make changes in dimensions, construction, price lists, or product literature without prior notice.

Order Entry

All orders are subject to final acceptance by Bernhardt Design in Lenoir, NC. Receipt of our acknowledgment indicates acceptance of your order subject to the terms set forth on the acknowledgment. Bernhardt Design attempts to clarify all purchase orders. However, in the event the price list number and description on the purchase order differ, the price list number will prevail.

Changes / Cancellation

All orders in production are considered firm orders and are not subject to changes or cancellation.

Custom Design

Bernhardt Design may alter products to meet specific needs. Contact your local sales representative when a custom design is needed. Custom designs require minimum quantities, additional lead time, and upcharges.

A custom job number, available from your local sales representative, must be submitted with purchase orders. Orders combining custom design with standard product cannot be scheduled for production until custom items are approved.

Custom design orders are not subject to revision or cancellation after acknowledgment.

Shipping

Bernhardt Design will ship in accordance with customer instructions whenever possible. If not specified, Bernhardt Design will exercise its best judgement in selecting a carrier. Orders in production will be shipped as scheduled and cannot be held.

High quality cartoning meeting trucking and railroad specifications is standard at no extra charge. Some items may be blanket wrapped for shipment.

Freight Damage and Claims

Bernhardt Design is not liable for damages that occur during transit or storage. The carrier assumes all responsibility upon acceptance of product. It is the customer's responsibility to inspect all products upon receipt and file any claims with the carrier. No product should be refused.

If products are received damaged, a written exception should be made on the bill of lading and an immediate inspection be requested of the carrier. Concealed damage must be reported to the carrier within 10 business days from date of delivery. Failure to make claims shall constitute acceptance of the products and waiver any claims of defects, errors or shortages.

In the event delivery is made on a Bernhardt Design truck, the products should be carefully inspected for transit damage. If contents are damaged, the driver should be notified to call his dispatcher for immediate disposition. Concealed damage must be reported within 10 business days from date of delivery and product/packaging held for inspection by a Bernhardt Design representative.

Replacements for product damaged in shipment or storage will be manufactured upon receipt of a purchase order.

Returns

No merchandise may be returned to Bernhardt Design without written consent in the form of a Return Authorization from our Quality Assurance Department stating why the item is being returned and how the item will be shipped.

Unauthorized returns will be automatically refused by our receiving department as well as returns not in accordance with Bernhardt Design shipping instructions. Liability for defective merchandise shall be limited to the replacement or repair of that merchandise, and Bernhardt Design shall not be liable for other damages or losses.

Measurements and Weights

All measurements and weights are approximate and subject to change without notice.

Care and Cleaning

Finished wood surfaces should be cleaned with a soft damp cloth, wiping in the direction of the grain. Furniture should be buffed dry immediately with a soft cloth.

Wood Finishes

Bernhardt Design tables are available in finishes that are compatible with casegoods and seating finishes. However, finishes on tables may vary slightly from those on casegoods and seating due to the natural characteristics of the wood. No absolute match is implied or guaranteed.

Light Finishes

Bernhardt Design offers lighter finishes 836, 837, 840, 850, and 870 on certain veneers. Light finishes do not hide or mask the natural characteristics of the wood. Therefore, inherent natural characteristics of the wood will vary from piece to piece when using a light finish. Natural characteristics include the natural discolorations of the wood substance and color variations in glued up stock. These natural characteristics are not considered defects by Bernhardt Design, and therefore merchandise will not be replaced.

Special Finishes

Special finishes, made to customer specifications and subject to factory approval, may be available at a **5% net upcharge with a \$500 net minimum**. Additional leadtime may be required for special finish items.

Special finish orders will not be acknowledged until the special finish sample is approved in writing and received by Bernhardt Design Customer Service. Special finish orders are not subject to revision or cancellation after acknowledgment.

Warranty

Bernhardt Design will repair or replace, at its discretion, any table product or part thereof which fails as the result of defects in material and workmanship, under single shift use and normal care for five years. This warranty shall apply only to the original purchaser.

This warranty does not cover normal wear and tear, misuse or abuse of product, dramatic temperature changes, exposure to unusual conditions or damages incurred by contact with seating products, casegoods or other surfaces.

Natural color changes, variations or movements in lumber or veneer products, exposure to extreme temperature changes and direct sunlight may cause color changes and/or surface damage. These are circumstances beyond the control of Bernhardt Design and are not warranty issues.

Repair or replacement of discontinued product will be at the discretion of Bernhardt Design.

This warranty is the customer's exclusive remedy for product defect and does not apply to damage caused by a freight carrier, dealer, installer, user modification, attachments to a product, or any third party. Bernhardt Design has the exclusive right to make the final determination of product misuse or abuse.

Except as stated above, Bernhardt Design makes no express or implied warranties as to any product, and in particular, makes no warranty of merchantability or of fitness for any particular purpose.

Bernhardt Design shall not be liable for any consequential or incidental damages or for commercial loss arising from any product defect.

Operational Parts Warranty

Drawer glides, drawer boxes, drawer pulls, and lock mechanisms have a Life-Time Warranty for original purchaser. Power and communication components are warranted for one year.

Design and Patent Rights

All of the products shown in Bernhardt Design catalogs and described in Bernhardt Design price lists are, and remain, the property of Bernhardt Design, with the sole right reserved to manufacture and to distribute.

Some of the product designs shown are patented in the United States and will remain the property of Bernhardt Design. Any reproduction of the products constitutes an infringement of patented copyright laws and will be subject to prosecution.

Bernhardt Design reserves the right to make changes in dimensions, design and/or construction, price lists, or product literature without prior notice.

Preferred Carrier Guaranteed Freight Rates

Freight charges will be applied to orders as a separate line item based on the zones listed. Rates are based on zones with a minimum for each zone. All zones are located within the Continental United States.

The freight amount is calculated on the total merchandise net price, excluding any extra discounts beyond standard net pricing. Additional freight fuel surcharges may apply. Rates are based on deliveries made Monday through Friday, 8 am until 5 pm.

All orders are shipped by Bernhardt Design company trucks or preferred carriers specified by Bernhardt Design. Dealer warehouse information, including phone number and contact name, must be specified on the purchase order.

Direct site deliveries may be requested with an additional freight cost. Requests for direct site deliveries must be made 2 weeks prior to the scheduled ship week and meet the following criteria:

- Minimum of half truckload
- Delivery site accessible by a 53' trailer
- Complete delivery site address with contact name and on-site phone number
- Labor available for unloading

Deliveries that do not meet the criteria must be directed to a receiver warehouse. If a receiver warehouse is not available, the dealer may make arrangements with their own 3rd party carrier. If a 3rd party carrier is elected, a contact name, phone number and e-mail address is required.

Weekend direct site deliveries will incur a \$500 per trailer weekend delivery fee. Weekend is defined as between 5 pm Friday and 8 am Monday.

Zone	Minimum Charge	Freight Rate	Average Service Days
1	\$80	5%	2-4 Business Days
2	\$80	6%	2-4 Business Days
3	\$90	7%	3-5 Business Days
4	\$90	8%	5-7 Business Days
5	\$90	9%	6-9 Business Days
6	\$110	10%	6-9 Business Days
7	\$110	11%	7-10 Business Days
8	\$120	12%	8-12 Business Days
9	\$120	13%	8-12 Business Days
10	\$120	15%	10-15 Business Days

Note: Average Service Days excludes ship day.

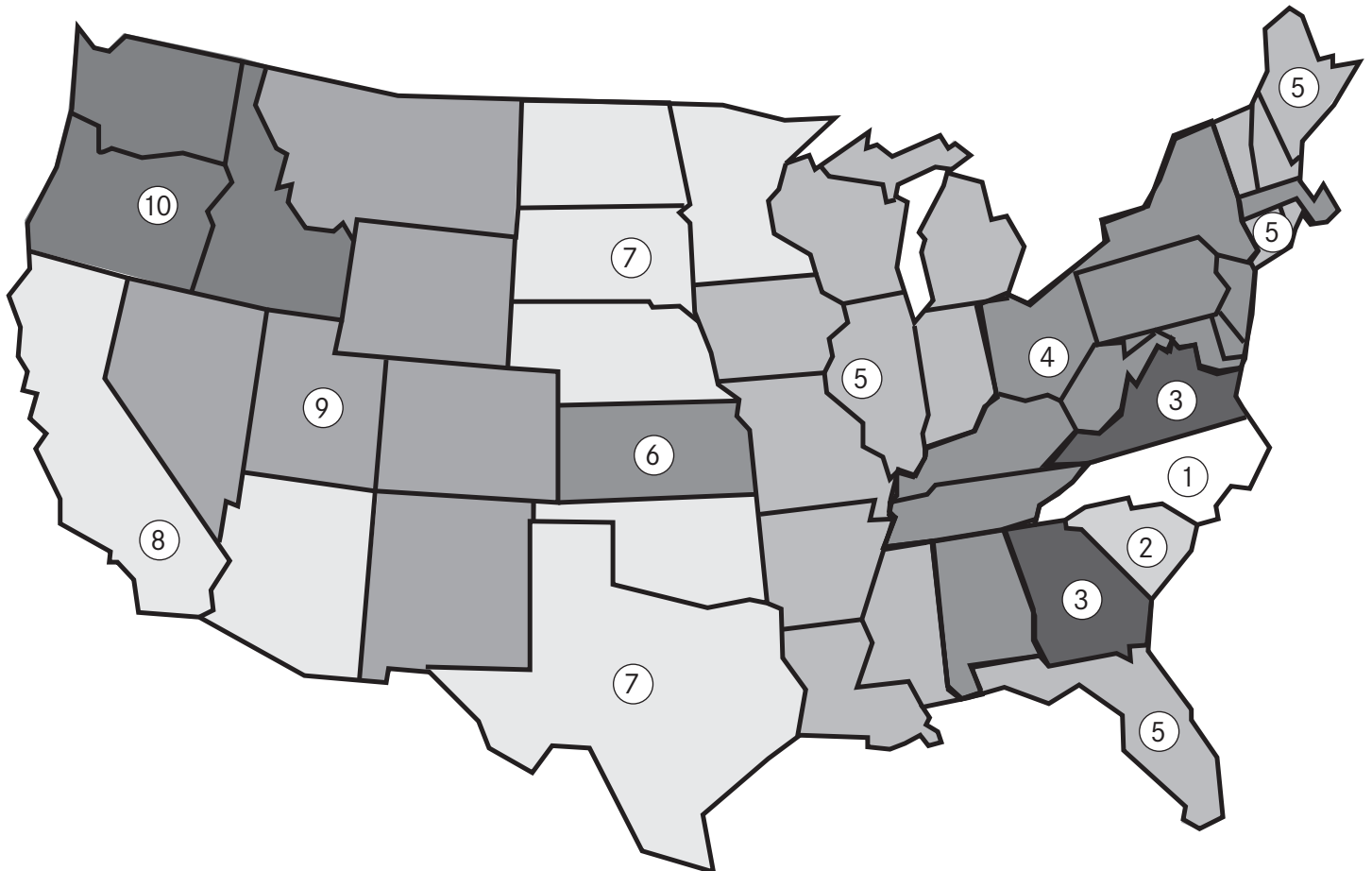

Veneer Selections

A three character sku identifies each species as well as the standard finish offered. Individual components are priced with standard finish. Special finishes on veneers made to customer specifications are subject to factory approval and a 5% net upcharge with a \$500 net minimum.

Transparent stains and sealers are applied in multiple steps to enhance the beauty of the natural wood. A durable, baked-on, top-coat of conversion varnish or UV topcoat is applied to protect the product. It is recommended that felt, cork or fabric backed desk pads and accessories are used on worksurfaces to minimize wear.

When specifying light finishes such as 836, 837, 840, 850 or 870, the color and characteristic variances of both veneer and solid wood are apparent. Therefore, exact color matches are not possible.

CHY Cherry

Flat Cut

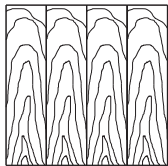

Standard Finish

- 805 840
- 834 841
- 836 861
- 839

MPL Maple

Flat Cut

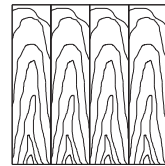

Standard Finish

- 837
- 850

OAK Oak

Rift Cut

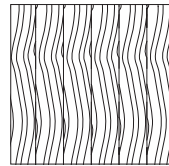

Standard Finish

- 805 860
- 836 861
- 837 865
- 839 866
- 840 870

WLT Walnut

Flat Cut

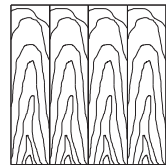

Standard Finish

- 823 861
- 839 866
- 841 870
- 860

Powerbar



Powerbar is offered in a 37" counter height and a 43" bar height in 24", 30", 36" and 42" widths with lengths in 12" increments ranging from 48" to 120".

The 24" wide console unit is single sided only and intended to be used against a wall; all other widths are configured to be used from both sides.

The top and end panels are 2 1/8" thick with miter corner details. Available with a solid wood front edge or an inset aluminum edge front trim. The end panels feature a removable wireway access cover in a brushed stainless steel finish.

Powerbar features an integral shelf for temporary storage of papers or electronics. Power options are available in multiple locations within the shelf opening or mounted in the worksurface.

Powerbar is specified and sold under one sku number. Tables 84" and under will be shipped assembled, and tables larger than 84" will be shipped KD unless otherwise requested.

Powerbar is BIFMA Level 2 and GREENGUARD certified. Visit the product page at Bernhardtdesign.com for BIFMA Level 2 and GREENGUARD certifications. For complete information regarding the Level 2 and GREENGUARD, please contact bgreen@bernhardt.com.

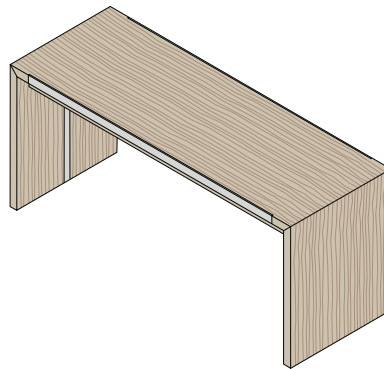

Counter Height: 37"

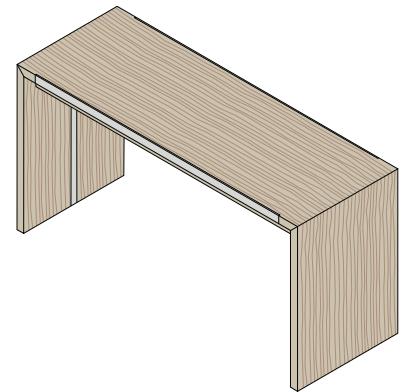

Bar Height: 43"

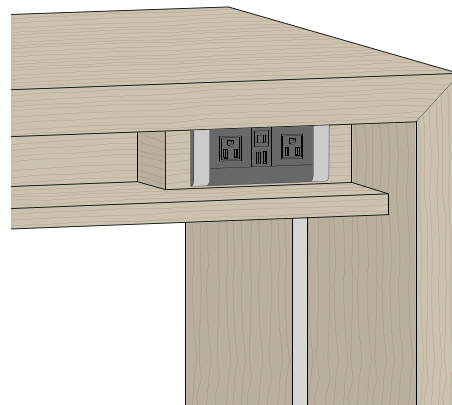

Miter corner with wood trim.
Specify edge style WD.

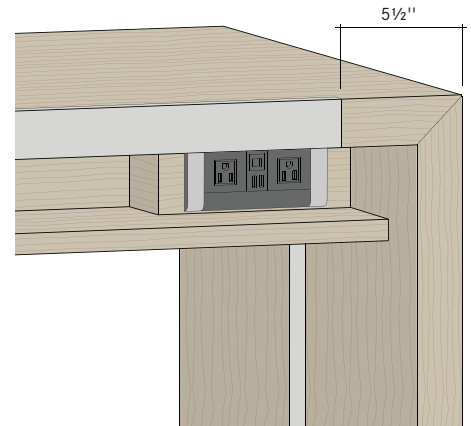

Miter corner with aluminum trim.
Specify edge style AL.

Powerbar Electrical / Wire Management

TeleAdapt



The TeleAdapt power module is offered for use in the shelf opening. This unit includes two grounded outlets, one 2.1 amp USB outlet and one 1.0 amp USB outlet with a 9 foot grounded plug. The unit is offered in aluminum and black trim. The TeleAdapt locations must be specified and the units ordered separately.

TeleAdapt modules may be used in conjunction with Surface Power Vaults. The Surface Power Vault locations must be specified and the units ordered separately.

24" Console Table

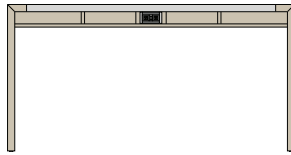

Center location one side.
Specify TeleAdapt location PT1.
Specify one VTT TeleAdapt unit.



End locations one side.
Specify TeleAdapt location PT2.
Specify two VTT TeleAdapt units.

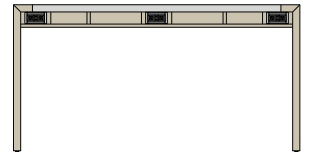

Center and end locations one side.
Specify TeleAdapt location PT3.
Specify three VTT TeleAdapt units.
For tops 108" and 120" only.

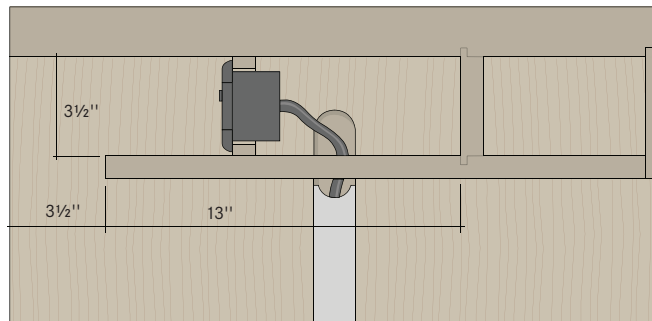

30" - 36" - 42" Tables

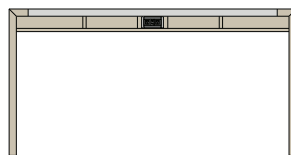

Center location both sides.
Specify TeleAdapt location PT1.
Specify two VTT TeleAdapt units.

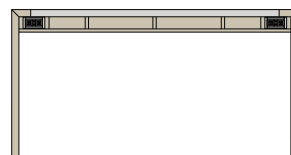

End locations both sides.
Specify TeleAdapt location PT2.
Specify four VTT TeleAdapt units.

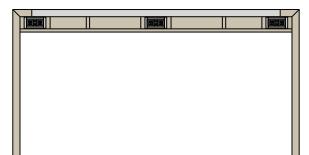

Center and end locations both sides.
Specify TeleAdapt location PT3.
Specify six VTT TeleAdapt units.
For tops 108" and 120" only.

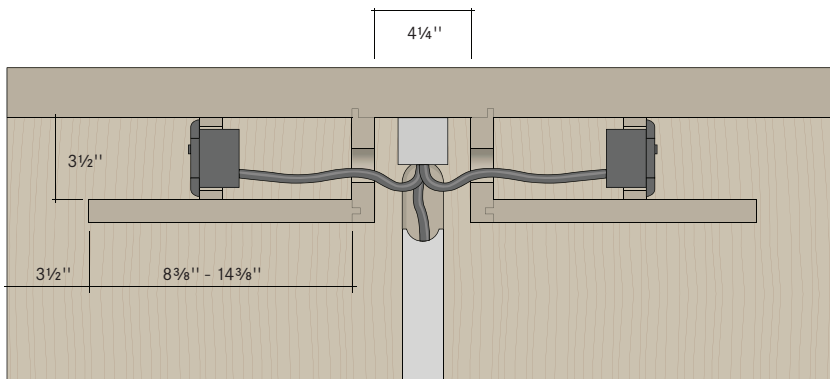

Powerbar Electrical / Wire Management

Surface Power Vault



For worksurface power requirements, the Surface Power Vault is a motorized power module that opens and closes by the touch of a button. Available with anodized aluminum cover and trim, the unit is equipped with a 12 foot grounded plug, three grounded outlets, and a 5v powered USB port.

The Surface Power Vault may be used in conjunction with TeleAdapt modules. The Surface Power Vault locations must be specified and the units ordered separately.

Power Harness

The power harness is designed to work with the TeleAdapt, the Surface Power Vault, or as an independent component. The VNY has six grounded outlets with a fifteen foot, 15 amp cord. Units are UL listed and CSA certified. Rated for 110 volt, at 15 amps.

24" Console Table

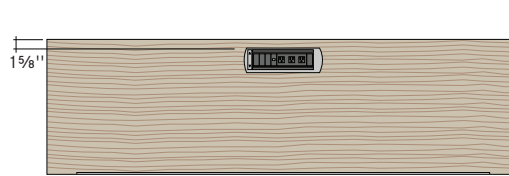

Center location.
Specify Surface Vault location 011.
Specify one STV Surface Vault.

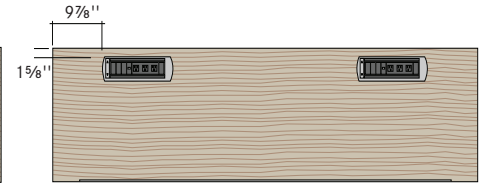

End locations.
Specify Surface Vault location 012.
Specify two STV Surface Vaults.

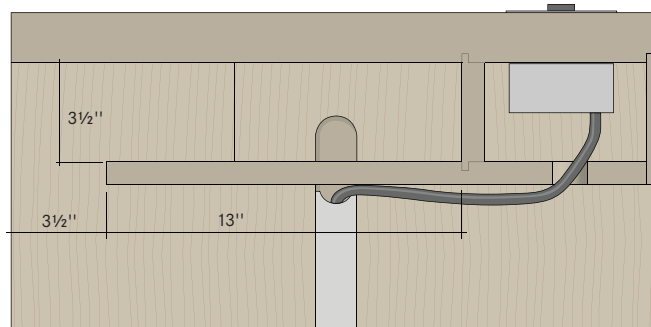

30" - 36" - 42" Tables

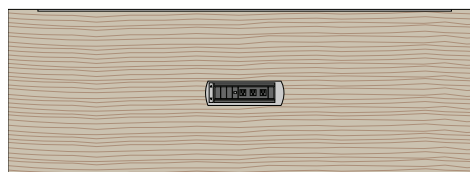

Center location.
Specify Surface Vault location 011.
Specify one STV Surface Vault.

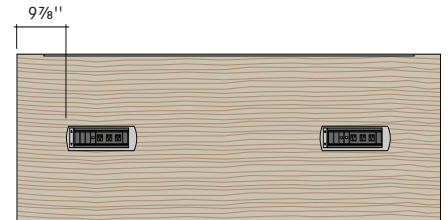

End locations.
Specify Surface Vault location 012.
Specify two STV Surface Vaults.

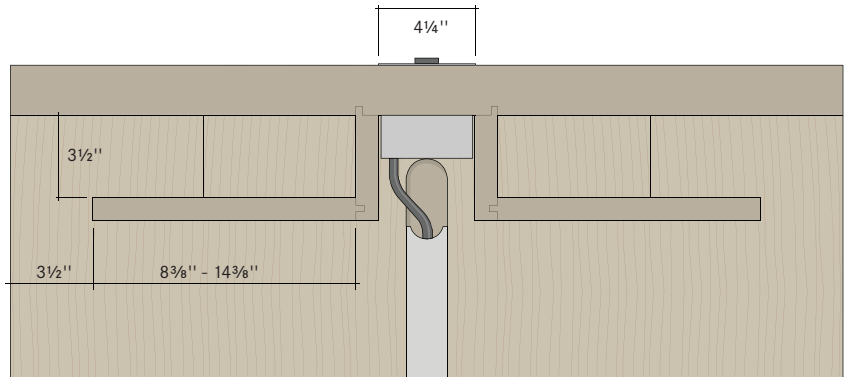

VNY

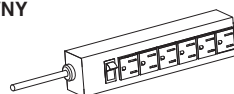



counter height powerbar table

24" w console designed for use against wall with aluminum trim and shelf power options for one side only
48" to 120" long in 12" increments
removable brushed stainless steel finish wireway access cover
specify separately TeleAdapt and Surface Power Vaults
GREENGUARD Certified

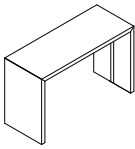
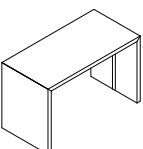
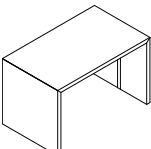
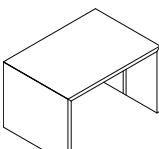
sku	w	d	h	weight	specifications	CHY cherry MPL maple OAK oak WLT walnut	
	C9A	48	24	37	164	shelf depth 14 1/4"	\$ 4037
	E9A	60	24	37	187	shelf depth 14 1/4"	4543
	G9A	72	24	37	211	shelf depth 14 1/4"	4855
	I9A	84	24	37	234	shelf depth 14 1/4"	5123
	K9A	96	24	37	257	shelf depth 14 1/4"	5394
	M9A	108	24	37	281	shelf depth 14 1/4"	5664
	O9A	120	24	37	304	shelf depth 14 1/4"	5935
	COA	48	30	37	179	shelf depth 8 3/8"	4735
	E0A	60	30	37	204	shelf depth 8 3/8"	5056
	G0A	72	30	37	229	shelf depth 8 3/8"	5467
	I0A	84	30	37	255	shelf depth 8 3/8"	5788
	K0A	96	30	37	280	shelf depth 8 3/8"	6113
	M0A	108	30	37	305	shelf depth 8 3/8"	6438
	O0A	120	30	37	330	shelf depth 8 3/8"	6763
	CAA	48	36	37	204	shelf depth 11 3/8"	5153
	EAA	60	36	37	236	shelf depth 11 3/8"	5527
	GAA	72	36	37	261	shelf depth 11 3/8"	5991
	IAA	84	36	37	289	shelf depth 11 3/8"	6368
	KAA	96	36	37	318	shelf depth 11 3/8"	6745
	MAA	108	36	37	347	shelf depth 11 3/8"	7124
	OAA	120	36	37	375	shelf depth 11 3/8"	7503
	CBA	48	42	37	234	shelf depth 14 3/8"	5570
	EBA	60	42	37	267	shelf depth 14 3/8"	5998
	GBA	72	42	37	300	shelf depth 14 3/8"	6516
	IBA	84	42	37	385	shelf depth 14 3/8"	6947
	KBA	96	42	37	366	shelf depth 14 3/8"	7378
	MBA	108	42	37	399	shelf depth 14 3/8"	7811
	OBA	120	42	37	431	shelf depth 14 3/8"	8245

specification codes example: PBS-SKU-WDPT1012

series	sku	edge	teleadapt location	surface vault location	material	finish
powerbar		WD wood AL aluminum	000 none PT1 center PT2 both ends PT3 center and both ends	000 none 011 center 012 both ends	CHY cherry MPL maple OAK oak WLT walnut	
P B S -	-					



bar height powerbar table

24" w console designed for use against wall with aluminum trim and shelf power options for one side only
48" to 120" long in 12" increments
removable brushed stainless steel finish wireway access cover
specify separately TeleAdapt and Surface Power Vaults
GREENGUARD Certified

	sku	w	d	h	weight	specifications		CHY cherry MPL maple OAK oak WLT walnut
	C9B	48	24	43	176	shelf depth 14 1/4"		\$ 4439
	E9B	60	24	43	199	shelf depth 14 1/4"		4712
	G9B	72	24	43	222	shelf depth 14 1/4"		5030
	I9B	84	24	43	246	shelf depth 14 1/4"		5304
	K9B	96	24	43	269	shelf depth 14 1/4"		5580
	M9B	108	24	43	292	shelf depth 14 1/4"		5857
	O9B	120	24	43	316	shelf depth 14 1/4"		6135
	COB	48	30	43	192	shelf depth 8 3/8"		4932
	EOB	60	30	43	217	shelf depth 8 3/8"		5260
	GOB	72	30	43	242	shelf depth 8 3/8"		5677
	IOB	84	30	43	267	shelf depth 8 3/8"		6006
	KOB	96	30	43	293	shelf depth 8 3/8"		6338
	MOB	108	30	43	318	shelf depth 8 3/8"		6671
	OOB	120	30	43	343	shelf depth 8 3/8"		7004
	CAB	48	36	43	218	shelf depth 11 3/8"		5382
	EAB	60	36	43	247	shelf depth 11 3/8"		5764
	GAB	72	36	43	276	shelf depth 11 3/8"		6238
	IAB	84	36	43	304	shelf depth 11 3/8"		6622
	KAB	96	36	43	333	shelf depth 11 3/8"		7010
	MAB	108	36	43	362	shelf depth 11 3/8"		7397
	OAB	120	36	43	391	shelf depth 11 3/8"		7785
	CBB	48	42	43	251	shelf depth 14 3/8"		5832
	EBB	60	42	43	284	shelf depth 14 3/8"		6272
	GBB	72	42	43	317	shelf depth 14 3/8"		6798
	IBB	84	42	43	350	shelf depth 14 3/8"		7239
	KBB	96	42	43	383	shelf depth 14 3/8"		7681
	MBB	108	42	43	416	shelf depth 14 3/8"		8123
	OBB	120	42	43	448	shelf depth 14 3/8"		8568

specification codes example: PBS-SKU-WDPT1012

series	sku	edge	teleadapt location	surface vault location	material	finish
powerbar		WD wood AL aluminum	000 none PT1 center PT2 both ends PT3 center and both ends	000 none 011 center 012 both ends	CHY cherry MPL maple OAK oak WLT walnut	
P B S -	-					

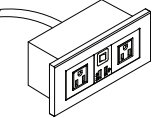
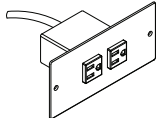
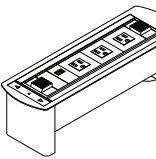
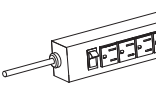
	description	sku	w	d	h	weight	specifications	price
	<p>teleadapt</p> <p>aluminum and black trim bezels included 9' cord with grounded plug 2 grounded outlets one 2.1 amp USB outlet one 1.0 amp USB outlet 120 volt - 10 amp UL approved recess depth of 2 3/8" 2" clearance below unit required to allow cables to exit specify location</p>	VTT	6 1/2	2 3/4	3 1/4		grounded plug	\$ 531
	<p>teleadapt</p> <p>black face plate 6' hardwired whip 2 grounded outlets 120 volt - 12 amp UL approved recess depth of 2 3/4" specify location</p>	VHW	6 1/2	2 3/4	3 1/4		hardwired	531
	<p>surface power vault</p> <p>surface mount 3 outlets 1 USB port aluminum frame specify location</p>	STV	13 7/8	4 1/4	4 1/8	5		1351
	<p>power strip</p> <p>6 outlet center; 110v 15 amp 15' plug in cord surge protector UL Listed specify pull/hardware code X</p>	VNY	12 1/4	2	1 3/4			358

specification codes example: ACS-SKU

series	sku
accessories A C S -	