

Zip Seating System Specification Guide

Zip is a modular seating product comprised of single and corner seat modules which may be used interchangeably to create different configurations. To select the modules that are appropriate for your application use the guide below. Zippers on the sides interlock pieces to create expandable modular configurations.

Zip is fully upholstered with flange stitch detailing and handles attached to the back. Handles are available in black or brown belting leather, fabric, leather alternatives and leather. Non-slip fabric applied to bottom. When ordering

multi-item configurations, please provide the total COM yardage from the same dye lot in a continuous roll(s). *All **COM/COL** fabrics must be preapproved by Bernhardt Design prior to application. See terms and conditions for instructions on tagging COM.

Please visit Bernhardtdesign.com for a complete library of 2D, 3D and Revit models. You may also contact your local sales representative or the Bernhardt Design corporate office for specification assistance. Approved for GSA. Contract GS-27F-010GA. Level 1 and GREENGUARD Certified.

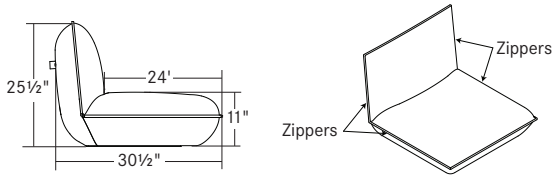

Single Seat

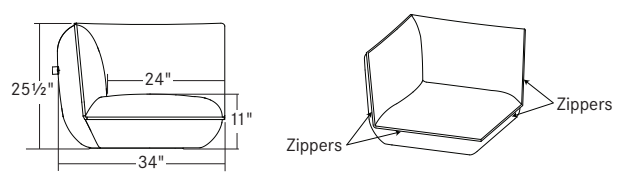

Corner Seat

Zip Sample Configurations

Description

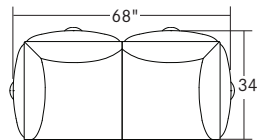
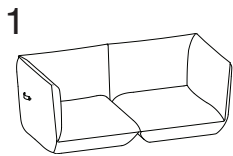

5871 Corner Seat (2)

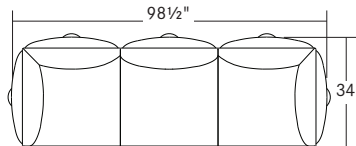
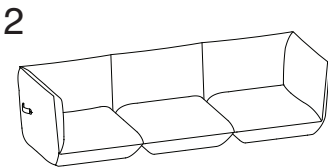

5871 Corner Seat
5870 Single Seat
5871 Corner Seat

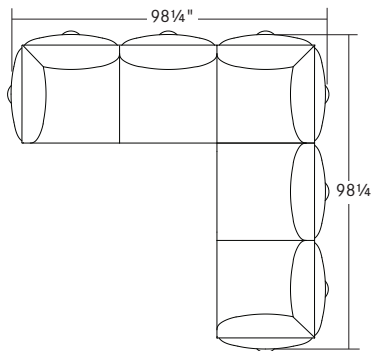
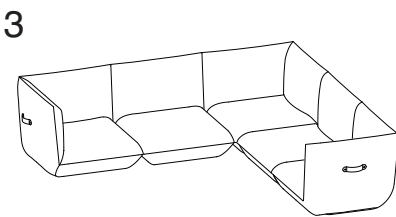

5871 Corner Seat
5870 Single Seat
5871 Corner Seat
5870 Single Seat
5871 Corner Seat

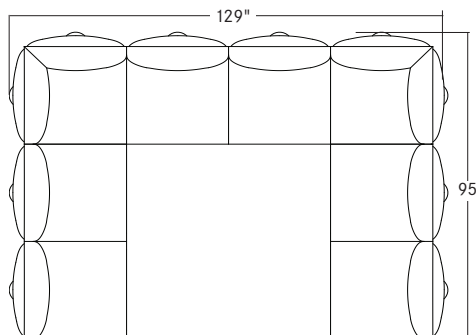
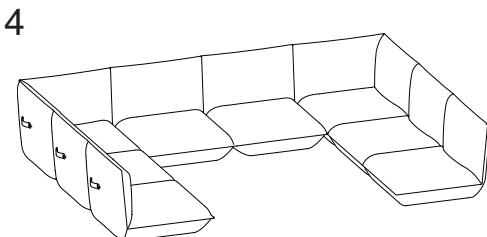

5870 Single Seat (2)
5871 Corner Seat
5870 Single Seat (2)
5871 Corner Seat
5870 Single Seat (2)

Seat Height		Arm Height		W	D	H	Fabric	Leather	Weight	Cubes/Qty.		
11"		-		30½"	34"	25½"	4.8 yds.	78.0'	49 lbs.	36.08' / 1		
279 mm		-		775 mm	864 mm	648 mm	4.4 m	7.2 sqm	22.3 kg	1.02 cu.		
COM	COL	1	2	3	4	5	6	7	8	9	10	11
1311	1407	1653	1706	1770	1807	1845	1866	1898	1946	2026	2101	2330

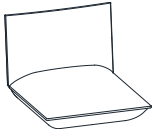

5870BL Black Belting Leather Handle

5870BR Brown Belting Leather Handle

Single Seat. Fully upholstered. Flange detail. Zipper attaches adjoining pieces. Specify 5870BL for black belting handle, 5870BR for brown belting handle. Non-slip base surface. Seat depth: 24" (610mm). When ordering multi-item configurations, please provide the total COM yardage from the same dye lot in a continuous roll(s). *All **COM/COL** fabrics must be preapproved by Bernhardt Design prior to application. See terms and conditions for instructions on tagging COM. GREENGUARD Certified.

Seat Height		Arm Height		W	D	H	Fabric	Leather	Weight	Cubes/Qty.		
11"		-		30½"	34"	25½"	4.8 yds.	78.0'	49 lbs.	36.08' / 1		
279 mm		-		775 mm	864 mm	648 mm	4.4 m	7.2 sqm	22.3 kg	1.02 cu.		
COM	COL	1	2	3	4	5	6	7	8	9	10	11
1475	1591	1888	1952	2030	2075	2120	2146	2184	2242	2339	2429	2706

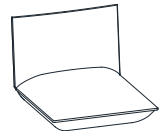

5870CM Fabric Handle

5870CL Leather Handle

Single Seat. Fully upholstered. Flange detail. Zipper attaches adjoining pieces. Specify 5870CM for COM handle, 5870CL for COL handle. Non-slip base surface. Seat depth: 24" (610mm). When ordering multi-item configurations, please provide the total COM yardage from the same dye lot in a continuous roll(s). *All **COM/COL** fabrics must be preapproved by Bernhardt Design prior to application. See terms and conditions for instructions on tagging COM. GREENGUARD Certified.

Contrasting Handle Specification: Handle is a different fabric or leather. For contrasting handle, the following yardage must be used and upcharges apply. See terms and conditions for contrasting fabric upcharges.

- A) One fabric or leather for body
yardage: 4.8 yds. leather: 78.0 sq. ft.
- B) One fabric for 1-20 handles or leather for 1-45 handles
yardage: 1.0 yds. leather: 20.0 sq. ft.

Please specify the fabric or leather application by designating the appropriate letter on the purchase order.

Seat Height		Arm Height		W	D	H	Fabric	Leather	Weight	Cubes/Qty.		
11"		-		34"	34"	25½"	6.5 yds.	110.0'	67 lbs.	36.08' / 1		
279 mm		-		864 mm	864 mm	648 mm	5.9 m	10.2 sqm	30.5 kg	1.02 cu.		
COM	COL	1	2	3	4	5	6	7	8	9	10	11
1747	1877	2210	2282	2369	2419	2470	2499	2542	2607	2715	2816	3127

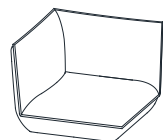

5871BL Black Belting Leather Handle

5871BR Brown Belting Leather Handle

Corner Seat. Fully upholstered. Flange detail. Zipper attaches adjoining pieces. Specify 5871BL for black belting handle, 5871BR for brown belting handle. Non-slip base surface. Seat depth: 24" (610mm). When ordering multi-item configurations, please provide the total COM yardage from the same dye lot in a continuous roll(s). *All **COM/COL** fabrics must be preapproved by Bernhardt Design prior to application. See terms and conditions for instructions on tagging COM. GREENGUARD Certified.

zip

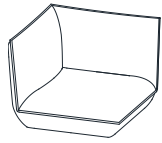

Seat Height	Arm Height	W	D	H	Fabric	Leather	Weight	Cubes/Qty.				
11"	-	34"	34"	25½"	6.5 yds.	110.0'	67 lbs.	36.08' / 1				
279 mm	-	864 mm	864 mm	648 mm	5.9 m	10.2 sqm	30.5 kg	1.02 cu.				
COM	COL	1	2	3	4	5	6	7	8	9	10	11
1912	2062	2446	2529	2629	2687	2746	2779	2829	2904	3029	3146	3504

5871CM Fabric Handle

5871CL Leather Handle

Corner Seat. Fully upholstered. Flange detail. Zipper attaches adjoining pieces. Specify 5871CM for COM handle, 5871CL for COL handle. Non-slip base surface. Seat depth: 24" (610mm). When ordering multi-item configurations, please provide the total COM yardage from the same dye lot in a continuous roll(s). *All **COM/COL** fabrics must be preapproved by Bernhardt Design prior to application. See terms and conditions for instructions on tagging COM. GREENGUARD Certified.

Contrasting Handle Specification: Handle is a different fabric or leather. For contrasting handle, the following yardage must be used and upcharges apply. See terms and conditions for contrasting fabric upcharges.

- A) One fabric or leather for body
 yardage: 6.5 yds. leather: 110.0 sq. ft.
- B) One fabric for 1-20 handles or leather for 1-45 handles
 yardage: 1.0 yds. leather: 20.0 sq. ft.

Please specify the fabric or leather application by designating the appropriate letter on the purchase order.