

a.k.a. floating credenzas

May 2018 Price List

index	2
collection overview	3
materials/finishes	4
ordering guide/product selection sequence	4
tops	5-7
wall mount assemblies	8-9
wall mount pedestals	10
guaranteed freight	11
terms and conditions	12-13

A.K.A. Floating Credenzas

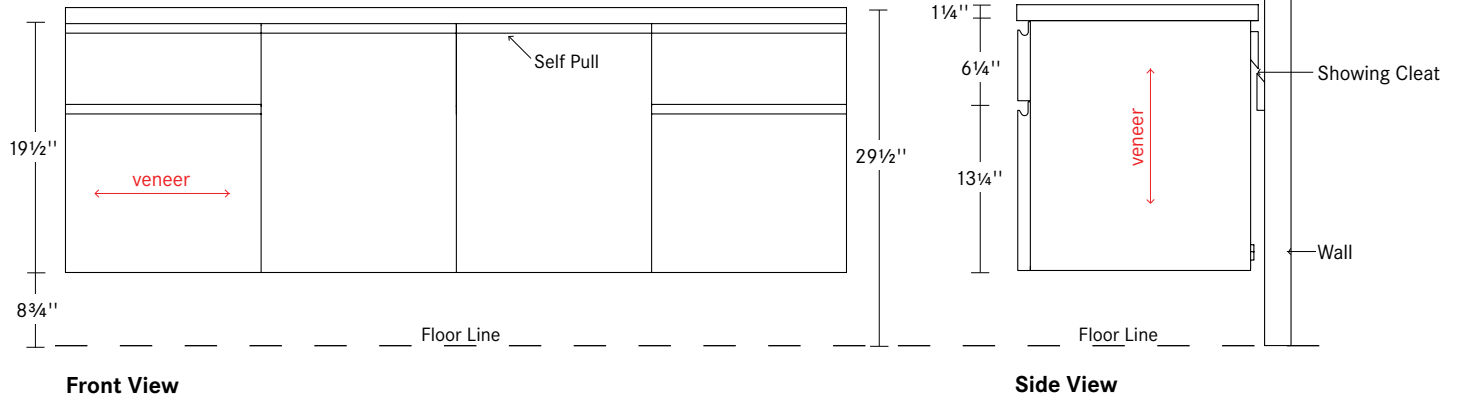

Materials/Finishes

A three character sku identifies each species as well as the standard finish offered. Individual components are priced with standard finish. Special finishes on veneers made to customer specifications are subject to factory approval and a 5% net upcharge with a \$500 net minimum.

Transparent stains and sealers are applied in multiple steps to enhance the beauty of the natural wood. A durable, baked-on, top-coat of

conversion varnish or UV topcoat is applied to protect the product. It is recommended that felt, cork or fabric backed desk pads and accessories are used on tops to minimize wear.

When specifying light finishes such as 836, 837, 840, 850 or 870, the color and characteristic variances of both veneer and solid wood are apparent. Therefore, exact color matches are not possible.

Veneer Selections



FL 1 1/4" Flat Edge

Pedestals/Assemblies

CHY Cherry

MPL Maple

WLT Walnut

Flat Cut

OAK Oak

PLD Paldao

Rift/Quarter Cut

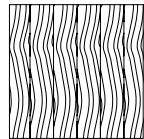
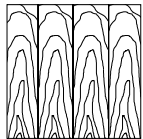

Standard Finishes

PNT Paint	CHY Cherry	MPL Maple	WLT Walnut	OAK Oak	PLD Paldao
100	805	837	823	805	823
101	834	850	839	836	839
102	836		841	837	841
103	839		860	839	860
104	840		861	840	861
105	841		866	860	866
106	861		870	861	870
108				865	
110				866	
111				870	
112					
113					
114					
115					

Glass Selections - Tops

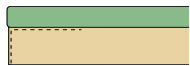

PL 1 1/4" Polished Flat Edge

GPW Back-Painted White Glass - Top

GEW Etched, Back-Painted White Glass - Top

Solid Surface Selections - Tops

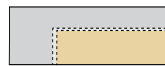

FL 1 1/4" Flat Edge

SSF Solid Surface

Standard Finish

CGW Corian, Glacier White

Pull/Hardware Selections

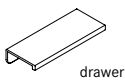

drawer

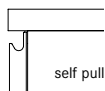

self pull

SF Self Pull

AA Brushed Aluminum

AG Brushed Graphite

Ordering Guide/Product Selection Sequence

1. Select top size
2. Select assemblies or pedestals

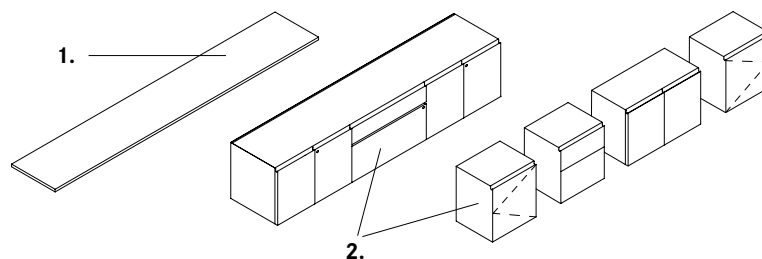

**tops - veneer
for pedestals 18⁷/₈"d**



tops - veneer for pedestals 18⁷/₈"d

1¹/₄"h veneer top

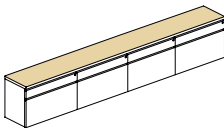
description	sku	w	d	h	CHY	MPL	OAK	WLT	PLD
					cherry	maple	oak	walnut	paldo
 veneer top	4BV	30	18 ⁷ / ₈	1 ¹ / ₄	\$ 712				\$ 826
	4BU	36	18 ⁷ / ₈	1 ¹ / ₄	765				888
	4BT	42	18 ⁷ / ₈	1 ¹ / ₄	818				949
	4BS	48	18 ⁷ / ₈	1 ¹ / ₄	876				1017
	4BR	54	18 ⁷ / ₈	1 ¹ / ₄	930				1079
	4BQ	60	18 ⁷ / ₈	1 ¹ / ₄	982				1140
	4BP	66	18 ⁷ / ₈	1 ¹ / ₄	1036				1202
	4BN	72	18 ⁷ / ₈	1 ¹ / ₄	1088				1263
	4BM	78	18 ⁷ / ₈	1 ¹ / ₄	1142				1325
	4BL	84	18 ⁷ / ₈	1 ¹ / ₄	1199				1391
	4BK	90	18 ⁷ / ₈	1 ¹ / ₄	1253				1454
	4BJ	96	18 ⁷ / ₈	1 ¹ / ₄	1306				1515
	4BI	102	18 ⁷ / ₈	1 ¹ / ₄	1449				1681
	4BH	108	18 ⁷ / ₈	1 ¹ / ₄	1502				1743
	4BG	114	18 ⁷ / ₈	1 ¹ / ₄	1566				1817
4BF	120	18 ⁷ / ₈	1 ¹ / ₄	1619				1879	

specification codes example: AKS-SKU-FL

series	sku	edge
a.k.a.		FL 1 ¹ / ₄ " flat
A K S -	-	F L

material/finish code example: WLT 839

material	finish
CHY cherry	see page 4
MPL maple	
OAK oak	
WLT walnut	
PLD paldao	

**tops - glass
for pedestals 18⁷/₈"d**



tops - glass for pedestals 18⁷/₈"d

1/2" glass top has veneer edge band subtop construction
specify material code GPW or GEW
specify subtop and subtop finish code

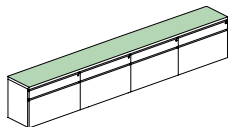
description	sku	w	d	h	GPW	GEW etched
					back-painted white glass	back-painted white glass
glass top 	4BV	30	18 ⁷ / ₈	1 ¹ / ₄	\$ 2144	\$ 2616
	4BU	36	18 ⁷ / ₈	1 ¹ / ₄	2228	2719
	4BT	42	18 ⁷ / ₈	1 ¹ / ₄	2334	2848
	4BS	48	18 ⁷ / ₈	1 ¹ / ₄	2452	2992
	4BR	54	18 ⁷ / ₈	1 ¹ / ₄	2568	3133
	4BQ	60	18 ⁷ / ₈	1 ¹ / ₄	2696	3290
	4BP	66	18 ⁷ / ₈	1 ¹ / ₄	2834	3458
	4BN	72	18 ⁷ / ₈	1 ¹ / ₄	2950	3599
	4BM	78	18 ⁷ / ₈	1 ¹ / ₄	3088	3768
	4BL	84	18 ⁷ / ₈	1 ¹ / ₄	3215	3923
	4BK	90	18 ⁷ / ₈	1 ¹ / ₄	3321	4052
	4BJ	96	18 ⁷ / ₈	1 ¹ / ₄	3501	4272
	4BI	102	18 ⁷ / ₈	1 ¹ / ₄	3639	4440
	4BH	108	18 ⁷ / ₈	1 ¹ / ₄	3767	4596
	4BG	114	18 ⁷ / ₈	1 ¹ / ₄	3905	4765
4BF	120	18 ⁷ / ₈	1 ¹ / ₄	4043	4933	

specification codes example: AKS-SKU-PL

series	sku	edge
a.k.a.		PL 1 1/4" polished flat
A K S -	-	P L

material/finish code example: GPW CHT 805

material	subtop	subtop finish
GPW glass back-painted white GEW glass etched back-painted white	PNT paint CHY cherry MPL maple OAK oak WLT walnut PLD paldao	see page 4

**tops - solid surface
for pedestals 18⁷/₈"d**



tops - solid surface for pedestals 18⁷/₈"d

1¹/₄"h solid surface tops

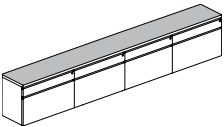
description	sku	w	d	h	SSF solid surface
 solid surface top	4BV	30	18 ⁷ / ₈	1 ¹ / ₄	\$ 1327
	4BU	36	18 ⁷ / ₈	1 ¹ / ₄	1412
	4BT	42	18 ⁷ / ₈	1 ¹ / ₄	1507
	4BS	48	18 ⁷ / ₈	1 ¹ / ₄	1608
	4BR	54	18 ⁷ / ₈	1 ¹ / ₄	1741
	4BQ	60	18 ⁷ / ₈	1 ¹ / ₄	1868
	4BP	66	18 ⁷ / ₈	1 ¹ / ₄	1985
	4BN	72	18 ⁷ / ₈	1 ¹ / ₄	2112
	4BM	78	18 ⁷ / ₈	1 ¹ / ₄	2366
	4BL	84	18 ⁷ / ₈	1 ¹ / ₄	2494
	4BK	90	18 ⁷ / ₈	1 ¹ / ₄	2622
	4BJ	96	18 ⁷ / ₈	1 ¹ / ₄	2749
	4BI	102	18 ⁷ / ₈	1 ¹ / ₄	2865
	4BH	108	18 ⁷ / ₈	1 ¹ / ₄	2982
	4BG	114	18 ⁷ / ₈	1 ¹ / ₄	3109
4BF	120	18 ⁷ / ₈	1 ¹ / ₄	3195	

specification codes example: AKS-SKU-FL

series	sku	edge
a.k.a.		FL 1 ¹ / ₄ " flat
A K S -	-	F L

material/finish code example: SSF CGW

material	finish
SSF solid surface	CGW glacier white
S S F	C G W



wall mount assemblies

designed to mount on drywall, cleat included on each cabinet
specify top separately

description	sku	w	d	h	specifications	PNT	CHY	MPL	OAK	WLT	PLD	paldao
						paint	cherry	maple	oak	walnut		
door assemblies 1 adjustable shelf	CDP	60	18 $\frac{7}{8}$	19 $\frac{1}{2}$	(2) 30" DD						\$ 3449	\$ 4001
	CDQ	72	18 $\frac{7}{8}$	19 $\frac{1}{2}$	(2) 36" DD						3545	4113
	CLT	90	18 $\frac{7}{8}$	19 $\frac{1}{2}$	(3) 30" DD						5178	6007
	CLU	108	18 $\frac{7}{8}$	19 $\frac{1}{2}$	(3) 30" DD						5316	6167

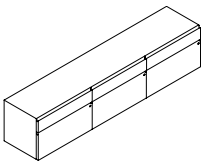
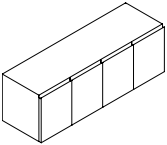

drawer assemblies

CFP	60	18 $\frac{7}{8}$	19 $\frac{1}{2}$	(2) 30" BF	4160	4826
CFQ	72	18 $\frac{7}{8}$	19 $\frac{1}{2}$	(2) 30" BF	4266	4949
CPT	90	18 $\frac{7}{8}$	19 $\frac{1}{2}$	(3) 30" BF	6234	723
CPU	108	18 $\frac{7}{8}$	19 $\frac{1}{2}$	(3) 36" BF	6398	7422

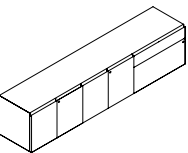

door/drawer assemblies

CEP	60	18 $\frac{7}{8}$	19 $\frac{1}{2}$	(1) 30" DD, (1) 30" BF	3900	452
CEQ	72	18 $\frac{7}{8}$	19 $\frac{1}{2}$	(1) 36" DD, (1) 36" BF	4016	4659
CST	90	18 $\frac{7}{8}$	19 $\frac{1}{2}$	(1) 36" DD, (2) 30" BF	6048	7016
CSU	108	18 $\frac{7}{8}$	19 $\frac{1}{2}$	(1) 36" DD, (2) 36" BF	6207	7201
CNS	90	18 $\frac{7}{8}$	19 $\frac{1}{2}$	(2) 30" DD, (1) 30" BF	5889	6832
CMS	108	18 $\frac{7}{8}$	19 $\frac{1}{2}$	(2) 36" DD, (1) 30" BF	6048	7016

specification codes example: AKS-SKU-SF

series	sku	pull
a.k.a.		SF self pull AA brushed aluminum AG brushed graphite
A K S -	-	

material/finish code example: WLT 839

material	finish
PNT paint CHY cherry MPL maple OAK oak WLT walnut PLD paldao	see page 4



wall mount assemblies

designed to mount on drywall, cleat included on each cabinet
specify top separately

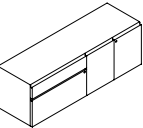
description	sku	w	d	h	specifications	PNT	CHY	MPL	OAK	WLT	PLD	paldao
						paint	cherry	maple	oak	walnut		
 <p>drawer/door assemblies 1 adjustable shelf</p>	CGP	60	18 $\frac{7}{8}$	19 $\frac{1}{2}$	(1) 30" BF, (1) 30" DD		3900					4524
	CGQ	72	18 $\frac{7}{8}$	19 $\frac{1}{2}$	(1) 36" BF, (1) 36" DD		4016					4659
	CQT	90	18 $\frac{7}{8}$	19 $\frac{1}{2}$	(2) 30" BF, (1) 30" DD		6048					7016
	CQU	108	18 $\frac{7}{8}$	19 $\frac{1}{2}$	(2) 36" BF, (1) 36" DD		6207					7201
	COT	90	18 $\frac{7}{8}$	19 $\frac{1}{2}$	(1) 30" BF, (2) 30" DD		5889					6832
	COU	108	18 $\frac{7}{8}$	19 $\frac{1}{2}$	(1) 36" BF, (2) 36" DD		6048					7016

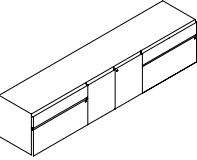
 <p>drawer/door drawer assemblies 1 adjustable shelf</p>	CRT	90	18 $\frac{7}{8}$	19 $\frac{1}{2}$	(2) 30" BF, (1) 30" DD		6048					7016
	CRU	108	18 $\frac{7}{8}$	19 $\frac{1}{2}$	(2) 36" BF, (1) 36" DD		6207					7201

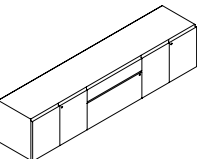
 <p>door/drawer drawer assemblies 1 adjustable shelf</p>	CNR	90	18 $\frac{7}{8}$	19 $\frac{1}{2}$	(2) 30" DD, (1) 30" BF		5889					6832
	CMR	108	18 $\frac{7}{8}$	19 $\frac{1}{2}$	(2) 36" DD, (1) 36" BF		6048					7016

specification codes example: AKS-SKU-SF

series	sku	pull
a.k.a.		SF self pull AA brushed aluminum AG brushed graphite
A K S -	-	

material/finish code example: WLT 839

material	finish
PNT paint CHY cherry MPL maple OAK oak WLT walnut PLD paldao	see page 4

**wall mount
pedestals**



wall mount pedestals

designed to mount on drywall, cleat included on each cabinet
specify top separately

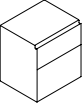
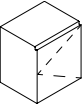
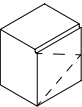
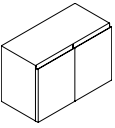
description	sku	w	d	h	specifications	PNT paint		PLD paldao
						CHY cherry	MPL maple	
						OAK oak	WLT walnut	
 floating pedestal box/file drawer	FJR	18	18 ⁷ / ₈	19 ¹ / ₂			\$ 1639	\$ 1902
	FJM	30	18 ⁷ / ₈	19 ¹ / ₂			1986	2304
	FJK	36	18 ⁷ / ₈	19 ¹ / ₂			2032	2358
 floating pedestal single door hinged left 1 adjustable shelf	FDR	18	18 ⁷ / ₈	19 ¹ / ₂			1327	1540
 floating pedestal single door hinged right 1 adjustable shelf	FFR	18	18 ⁷ / ₈	19 ¹ / ₂			1327	1540
 floating cabinet double doors 1 adjustable shelf	FDM	30	18 ⁷ / ₈	19 ¹ / ₂	(1) 30" DD		1728	2005
	FDK	36	18 ⁷ / ₈	19 ¹ / ₂	(1) 36" DD		1770	2054

specification codes example: AKS-SKU-SF

series	sku	pull
a.k.a.		SF self pull AA brushed aluminum AG brushed graphite
A K S -	-	

material/finish code example: WLT 839

material	finish
PNT paint CHY cherry MPL maple OAK oak WLT walnut PLD paldao	see page 4

Preferred Carrier Guaranteed Freight Rates

Freight charges will be applied to orders as a separate line item based on the zones listed. Rates are based on zones with a minimum for each zone. All zones are located within the Continental United States.

The freight amount is calculated on the total merchandise net price, excluding any extra discounts beyond standard net pricing. Additional freight fuel surcharges may apply. Rates are based on deliveries made Monday through Friday, 8 am until 5 pm.

All orders are shipped by Bernhardt Design company trucks or preferred carriers specified by Bernhardt Design. Dealer warehouse information, including phone number and contact name, must be specified on the purchase order.

Direct site deliveries may be requested with an additional freight cost. Requests for direct site deliveries must be made 2 weeks prior to the scheduled ship week and meet the following criteria:

- Minimum of half truckload
- Delivery site accessible by a 53' trailer
- Complete delivery site address with contact name and on-site phone number
- Labor available for unloading

Deliveries that do not meet the criteria must be directed to a receiver warehouse. If a receiver warehouse is not available, the dealer may make arrangements with their own 3rd party carrier. If a 3rd party carrier is elected, a contact name, phone number and e-mail address is required.

Weekend direct site deliveries will incur a \$500 per trailer weekend delivery fee. Weekend is defined as between 5 pm Friday and 8 am Monday.

Zone	Minimum Charge	Freight Rate	Average Service Days
1	\$80	5%	2-4 Business Days
2	\$80	6%	2-4 Business Days
3	\$90	7%	3-5 Business Days
4	\$90	8%	5-7 Business Days
5	\$90	9%	6-9 Business Days
6	\$110	10%	6-9 Business Days
7	\$110	11%	7-10 Business Days
8	\$120	12%	8-12 Business Days
9	\$120	13%	8-12 Business Days
10	\$120	15%	10-15 Business Days

Note: Average Service Days excludes ship day.

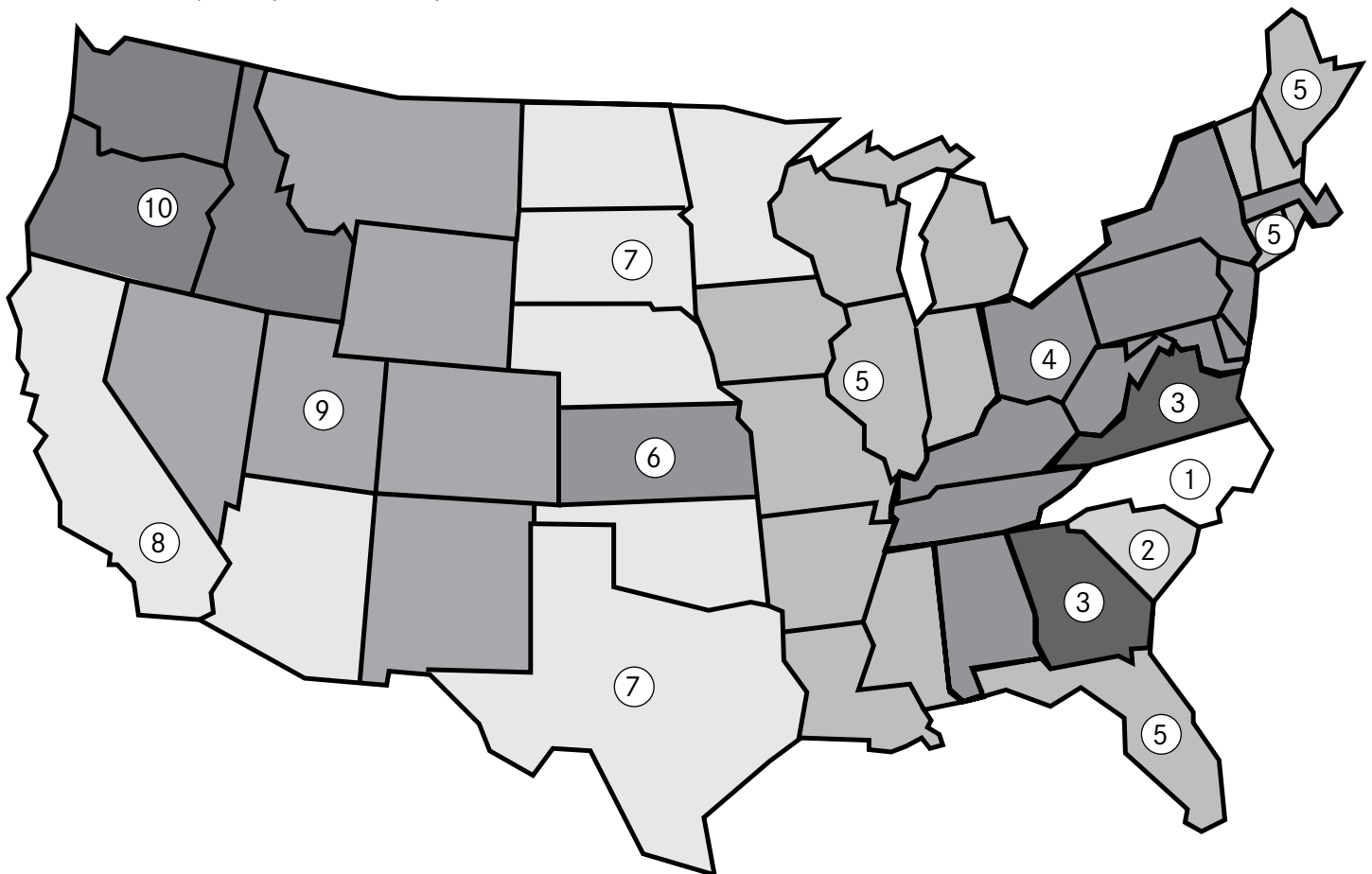

Sales and Service Policy

Guidelines detailing the operating policies and procedures of Bernhardt Design are provided in the Sales and Service Policy available online at <http://www.bernhardtdesign.com/sales-and-service-policy>.

Prices and Specifications

Prices and specifications are subject to change without notice. All prices quoted will be FOB our factories. If applicable, sales tax will be based on ship-to destination.

Bernhardt Design reserves the right to make changes in dimensions, construction, price lists, or product literature without prior notice.

Order Entry

All orders are subject to final acceptance by Bernhardt Design in Lenoir, NC. Receipt of our acknowledgment indicates acceptance of your order subject to the terms set forth on the acknowledgment. Bernhardt Design attempts to clarify all purchase orders. However, in the event the price list number and description on the purchase order differ, the price list number will prevail.

Changes / Cancellation

All orders in production are considered firm orders and are not subject to changes or cancellation.

Custom Design

Bernhardt Design may alter products to meet specific needs. Contact your local sales representative when a custom design is needed. Custom designs require minimum quantities, additional lead time, and upcharges.

A custom job number, available from your local sales representative, must be submitted with purchase orders. Orders combining custom design with standard product cannot be scheduled for production until custom items are approved. Custom design orders are not subject to revision or cancellation after acknowledgment.

Shipping

Bernhardt Design will ship in accordance with customer instructions whenever possible. If not specified, Bernhardt Design will exercise its best judgment in selecting a carrier. Orders in production will be shipped as scheduled and cannot be held.

High quality cartoning meeting trucking and railroad specifications is standard at no extra charge. Some items may be blanket wrapped for shipment.

Freight Damage and Claims

Bernhardt Design is not liable for damages that occur during transit or storage. The carrier assumes all responsibility upon acceptance of product. It is the customer's responsibility to inspect all products upon receipt and file any claims with the carrier. No product should be refused.

If products are received damaged, a written exception should be made on the bill of lading and an immediate inspection be requested of the carrier. Concealed damage must be reported to the carrier within 10 business days from date of delivery.

Failure to make claims shall constitute acceptance of the products and waiver any claims of defects, errors or shortages.

In the event delivery is made on a Bernhardt Design truck, the products should be carefully inspected for transit damage. If contents are damaged, the driver should be notified to call his dispatcher for immediate disposition.

Concealed damage must be reported within 10 business days from date of delivery and product/packaging held for inspection by a Bernhardt Design representative.

Replacements for product damaged in shipment or storage will be manufactured upon receipt of a purchase order.

Returns

No merchandise may be returned to Bernhardt Design without written consent in the form of a Return Authorization from our Quality Assurance Department stating why the item is being returned and how the item will be shipped.

Unauthorized returns will be automatically refused by our receiving department as well as returns not in accordance with Bernhardt Design shipping instructions. Liability for defective merchandise shall be limited to the replacement or repair of that merchandise, and Bernhardt Design shall not be liable for other damages or losses.

Measurements and Weights

All measurements and weights are approximate and subject to change without notice.

Care and Cleaning

Finished wood surfaces should be cleaned with a soft damp cloth, wiping in the direction of the grain. Furniture should be buffed dry immediately with a soft cloth.

Wood Finishes

Bernhardt Design tables are available in finishes that are compatible with casegoods and seating finishes. However, finishes on tables may vary slightly from those on casegoods and seating due to the natural characteristics of the wood. No absolute match is implied or guaranteed.

Light Finishes

Bernhardt Design offers lighter finishes 836, 837, 840, 850, and 870 on certain veneers. Light finishes do not hide or mask the natural characteristics of the wood. Therefore, inherent natural characteristics of the wood will vary from piece to piece when using a light finish. Natural characteristics include the natural discolorations of the wood substance and color variations in glued up stock. These natural characteristics are not considered defects by Bernhardt Design, and therefore merchandise will not be replaced.

Special Finishes

Special finishes, made to customer specifications and subject to factory approval, may be available at a **5% net upcharge with a \$500 net minimum.**

Additional leadtime may be required for special finish items. Special finish orders will not be acknowledged until the special finish sample is approved in writing and received by Bernhardt Design Customer Service. Special finish orders are not subject to revision or cancellation after acknowledgment.

Installation and Maintenance

All freestanding casegoods are equipped with leveling devices. Local floor conditions vary, and it is always necessary to properly adjust leveling devices. Proper leveling is essential to the alignment and function of doors and drawers. Improperly leveled units result in misaligned doors and drawers and may impair locking mechanisms or other functional hardware.

After the initial installation of casegoods, it may be necessary to readjust and align the units to compensate for settling. This should be expected as a matter of routine maintenance and follow-up to assure proper case function.

Proper installation of Bernhardt Design casegoods is the responsibility of the dealer. Improperly installed units can result in permanent damage to case components. Damage due to improperly installed furniture not covered under product warranty.

Warranty

Bernhardt Design will repair or replace, at its discretion, any casegoods product or part thereof which fails as the result of defects in material and workmanship, under single shift use and normal care for five years. This warranty shall apply only to the original purchaser. This warranty does not cover normal wear and tear, misuse or abuse of product, dramatic temperature changes, exposure to unusual conditions or damages incurred by contact with seating products, tables, desks or other surfaces.

Natural color changes, variations or movements in lumber or veneer products, exposure to extreme temperature changes and direct sunlight may cause color changes and/or surface damage. These are circumstances beyond the control of Bernhardt Design and are not warranty issues. Repair or replacement of discontinued product will be at the discretion of Bernhardt Design.

This warranty is the customer's exclusive remedy for product defect and does not apply to damage caused by a freight carrier, dealer, installer, user modification, attachments to a product, or any third party. Bernhardt Design has the exclusive right to make the final determination of product misuse or abuse.

Except as stated above, Bernhardt Design makes no express or implied warranties as to any product, and in particular, makes no warranty of merchantability or of fitness for any particular purpose. Bernhardt Design shall not be liable for any consequential or incidental damages or for commercial loss arising from any product defect.

Operational Parts Warranty

Drawer glides, drawer boxes, drawer pulls, and lock mechanisms have a Life-Time Warranty for original purchaser. Power and communication components are warranted for one year.

Wall Mount Units Warranty

Wall mounted units are supplied with an adequate attachment device but not with hardware to attach this device to the support wall. It is the responsibility of the dealer/installer to ensure the wall structure is adequate to support the unit and that the attachment device is properly secured to the wall structure.

Design and Patent Rights

All of the products shown in Bernhardt Design catalogs and described in Bernhardt Design price lists are, and remain, the property of Bernhardt Design, with the sole right reserved to manufacture and to distribute.

Some of the product designs shown are patented in the United States and will remain the property of Bernhardt Design. Any reproduction of the products constitutes an infringement of patented copyright laws and will be subject to prosecution.

Bernhardt Design reserves the right to make changes in dimensions, design and/or construction, price lists, or product literature without prior notice.