

cp.4 credenzas

May 2018 Price List

index	2
collection overview	3
materials/finishes	4
72" credenzas	5-6
84" credenzas	7-8
90" credenzas	9
96" credenzas	10-11
108" credenzas	12-13
120" credenzas	14-15
tops - glass	16
accessories	17
guaranteed freight	18
terms and conditions	19-20

Cp.4 Credenzas

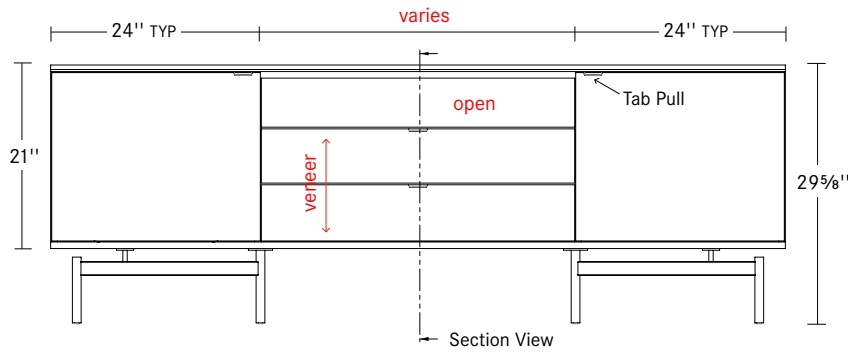

Front View

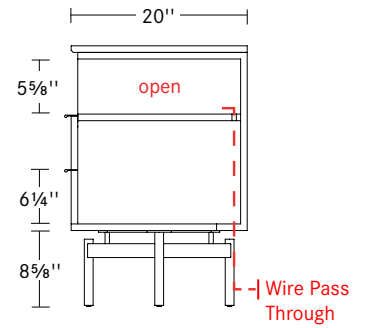

Section View

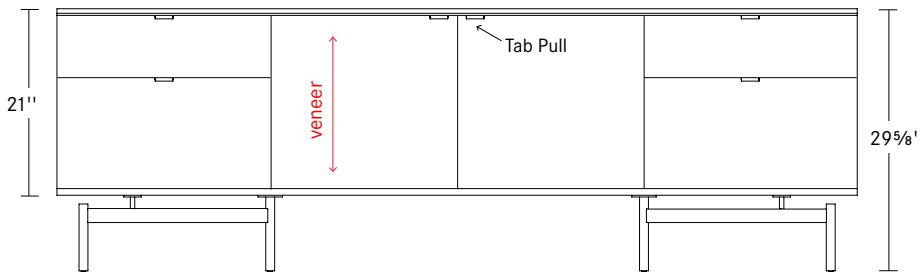

Front View

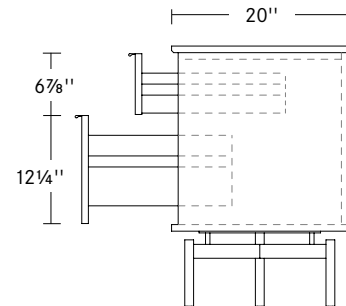

Side View

Trash/Recycling Bin

Slideout, dual compartment trash/recycling bin
 Bin ships assembled
 Includes: (1) open-top 30 liter bin and (1) open-top 19 liter bin
 Overall size: 16 7/8" w x 18 1/4" d x 17 7/8" h
 Gray LLDPE

1" square adhesive backed trash and recycled icons included for optional on-site installation.

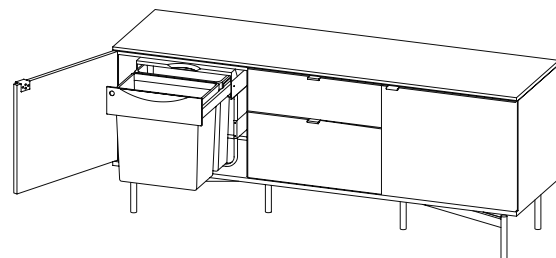

Glass Detail

Bernhardt Design offers a 3/8" thick back-painted glass top for placement on top of any CP.4 credenza. Glass top is offered in etched back-painted white, etched back-painted black and polished back-painted white.

When installing, position the glass top 1/2" from the front and sides, keeping it flush with the back of the credenza.

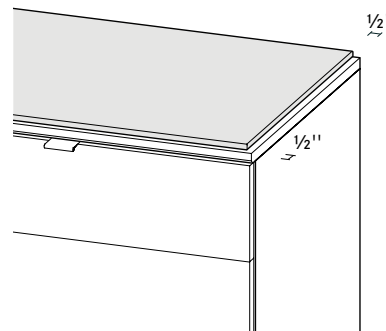

Materials/Finishes

A three character sku identifies each species as well as the standard finish offered. Individual components are priced with standard finish. Special finishes on veneers made to customer specifications are subject to factory approval and a 5% net upcharge with a \$500 net minimum.

Transparent stains and sealers are applied in multiple steps to enhance the beauty of the natural wood. A durable, baked-on, top-coat of conversion varnish or UV topcoat is applied to protect the product.

It is recommended that felt, cork or fabric backed desk pads and accessories are used on tops to minimize wear. When specifying light finishes such as 836, 837, 840, 850 or 870, the color and characteristic variances of both veneer and solid wood are apparent. Therefore, exact color matches are not possible.

Cp.4 Credenzas are available with vertical veneer inside all the door cabinets and finished backs suitable for open area installations.

Veneer Selections



FL 3/4" Flat Edge

Tops/Pedestals

- CHY Cherry
- MPL Maple
- WLT Walnut
- Flat Cut
- OAK Oak
- PLD Paldao
- Rift/Quarter Cut

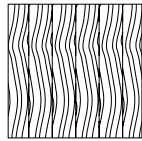
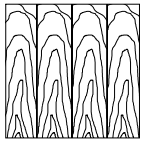

Standard Finishes

CHY Cherry	MPL Maple	WLT Walnut	OAK Oak	PLD Paldao
805	837	823	805	823
834	850	839	836	839
836		841	837	841
839		860	839	860
840		861	840	861
841		866	860	866
861		870	861	870
			865	
			866	
			870	

Glass Selections - Tops

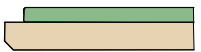

PL 3/8" Polished Flat Edge

- GPW Back-Painted White Glass
- GEW Etched, Back-Painted White Glass
- GEB Etched, Back-Painted Black Glass

Pull/Hardware Selections

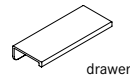

- TB Black Tab
- TC Chrome Tab

Base Selections

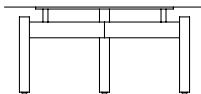

- BK Matte Black Powdercoat
- SS Polished Stainless Steel

72" credenzas

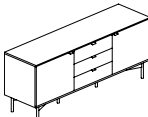
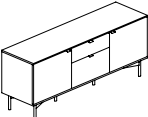

72" credenzas

	sku	w	d	h	specifications	CHY cherry MPL maple OAK oak WLT walnut	PLD paldao
	CBN	72	20	29½	(2) 24" w doors with adjustable shelves (3) 24" w standard storage drawers	\$ 6067	\$ 6978
	CCN	72	20	29½	(2) 24" w doors with adjustable shelves (1) 24" w standard storage drawer (1) 24" w deep storage drawer	6000	6900
	CDN	72	20	29½	(2) 24" w doors with adjustable shelves (1) 24" w open shelf (2) 24" w standard storage drawers	6075	6987
	CEN	72	20	29½	(2) 24" w doors with adjustable shelves (1) 24" w open shelf (1) 24" w deep storage drawer	6000	6900
	CFN	72	20	29½	(2) 24" w standard storage drawers (3) 24" w deep storage drawers (1) 24" w open shelf	6075	6987

specification codes example: C4S-SKU-TB

series	sku	pull
C 4 S -	-	TB black tab TC chrome tab

material/finish code example: BK CHY 805

base finish	material	finish
BK black powdercoat base SS stainless steel base	CHY cherry MPL maple OAK oak WLT walnut PLD paldao	see page 4

72" credenzas

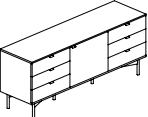
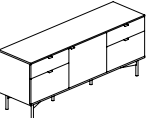
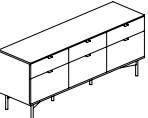

72" credenzas

description	sku	w	d	h	specifications	CHY cherry	MPL maple	OAK oak	WLT walnut	PLD paldao
	CGN	72	20	29½	(6) 24" w standard storage drawers (1) 24" w door with adjustable shelf	\$ 6150				\$ 7073
	CHN	72	20	29½	(2) 24" w standard storage drawers (2) 24" w deep storage drawers (1) 24" w door with adjustable shelf	6075				6987
	CIN	72	20	29½	(3) 24" w standard storage drawers (3) 24" w deep storage drawers	6150				7073

specification codes example: C4S-SKU-TB

series	sku	pull
C 4 S -	-	TB black tab TC chrome tab

material/finish code example: BK CHY 805

base finish	material	finish
BK black powdercoat base SS stainless steel base	CHY cherry MPL maple OAK oak WLT walnut PLD paldao	see page 4

84" credenzas

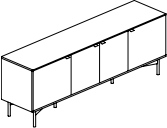
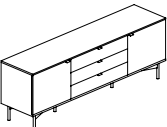
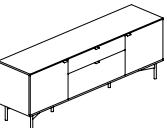
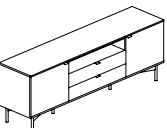
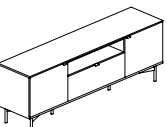

84" credenzas

description	sku	w	d	h	specifications	CHY cherry	MPL maple	OAK oak	WLT walnut	PLD paldao
	CAL	84	20	29½	(2) 24" w doors with adjustable shelves (1) 36" w double door with adjustable shelf	\$ 6125				\$ 7044
	CBL	84	20	29½	(2) 24" w doors with adjustable shelves (3) 36" w standard storage drawers	6200				7130
	CCL	84	20	29½	(2) 24" w doors with adjustable shelves (1) 36" w standard storage drawer (1) 36" w deep storage drawer	6125				7044
	CDL	84	20	29½	(2) 24" w doors with adjustable shelves (1) 36" w open shelf (2) 36" w standard storage drawers	6250				7188
	CEL	84	20	29½	(2) 24" w doors with adjustable shelves (1) 36" w open shelf (1) 36" w deep storage drawer	6125				7044

specification codes example: C4S-SKU-TB

series	sku	pull
C 4 S -	-	TB black tab TC chrome tab

material/finish code example: BK CHY 805

base finish	material	finish
BK black powdercoat base SS stainless steel base	CHY cherry MPL maple OAK oak WLT walnut PLD paldao	see page 4

84" credenzas

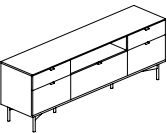
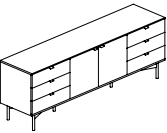
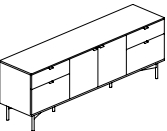
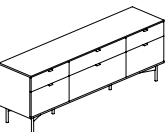

84" credenzas

	sku	w	d	h	specifications	CHY cherry MPL maple OAK oak WLT walnut	PLD paldao
	CFL	84	20	29½	(2) 24" w standard storage drawers (2) 24" w deep storage drawers (1) 36" w open shelf (1) 36" w deep storage drawer	\$ 6250	\$ 7188
	CGL	84	20	29½	(6) 24" w standard storage drawers (1) 36" w double door with adjustable shelf	6300	7245
	CHL	84	20	29½	(2) 24" w standard storage drawers (2) 24" w deep storage drawers (1) 36" w double door with adjustable shelf	6250	7188
	CIL	84	20	29½	(2) 24" w standard storage drawers (2) 24" w deep storage drawers (1) 36" w standard storage drawer (1) 36" w deep storage drawer	6300	7245

specification codes example: C4S-SKU-TB

series	sku	pull
C 4 S -	-	TB black tab TC chrome tab

material/finish code example: BK CHY 805

base finish	material	finish
BK black powdercoat base SS stainless steel base	CHY cherry MPL maple OAK oak WLT walnut PLD paldao	see page 4

90" credenzas

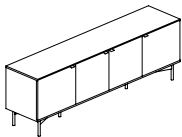
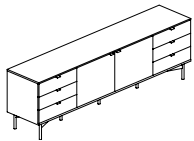
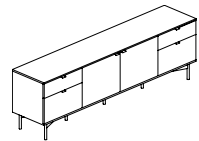

90" credenzas

description	sku	w	d	h	specifications	CHY cherry	MPL maple	OAK oak	WLT walnut	PLD paldao
	CAK	90	20	29½	(2) 24" w doors with adjustable shelves	\$ 6250				\$ 7188
					(2) 21" w doors with adjustable shelves					
	CGK	90	20	29½	(6) 24" w standard storage drawers	6550				7533
					(2) 21" w doors with adjustable shelves					
	CHK	90	20	29½	(2) 24" w standard storage drawers	6450				7418
					(2) 24" w deep storage drawers					
					(2) 21" w doors with adjustable shelves					

specification codes example: C4S-SKU-TB

series	sku	pull
C 4 S -	-	TB black tab TC chrome tab

material/finish code example: BK CHY 805

base finish	material	finish
BK black powdercoat base SS stainless steel base	CHY cherry MPL maple OAK oak WLT walnut PLD paldao	see page 4

96" credenzas

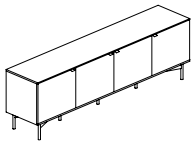
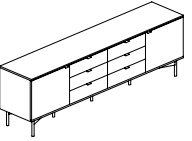
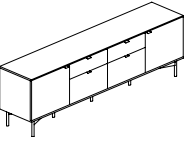
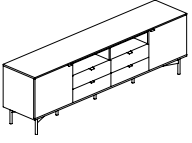
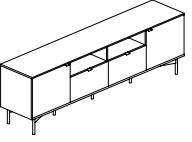

96" credenzas

	sku	w	d	h	specifications	CHY cherry MPL maple OAK oak WLT walnut	PLD paldao
	CAJ	96	20	29½	(4) 24" w doors with adjustable shelves	\$ 6950	\$ 7993
	CBJ	96	20	29½	(2) 24" w doors with adjustable shelves (6) 24" w standard storage drawers	7075	8137
	CCJ	96	20	29½	(2) 24" w doors with adjustable shelves (2) 24" w standard storage drawers (2) 24" w deep storage drawers	6950	7993
	CDJ	96	20	29½	(2) 24" w doors with adjustable shelves (2) 23⅝" w open shelves (4) 24" w standard storage drawers	7075	8137
	CEJ	96	20	29½	(2) 24" w doors with adjustable shelves (2) 23⅝" w open shelves (2) 24" w deep storage drawers	6950	7993

specification codes example: C4S-SKU-TB

series	sku	pull
C 4 S -	-	TB black tab TC chrome tab

material/finish code example: BK CHY 805

base finish	material	finish
BK black powdercoat base SS stainless steel base	CHY cherry MPL maple OAK oak WLT walnut PLD paldao	see page 4

96" credenzas

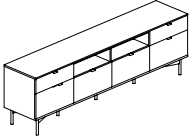
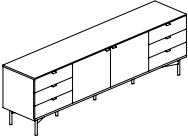
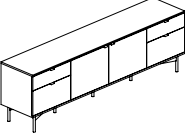
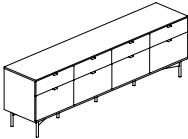

96" credenzas

	sku	w	d	h	specifications	CHY cherry MPL maple OAK oak WLT walnut	PLD paldao
	CFJ	96	20	29½	(2) 24" w standard storage drawers (4) 24" w deep storage drawers (2) 23½" w open shelves	\$ 7075	\$ 8137
	CGJ	96	20	29½	(6) 24" w standard storage drawers (2) 24" w doors with adjustable shelves	7175	8252
	CHJ	96	20	29½	(2) 24" w standard storage drawers (2) 24" w deep storage drawers (2) 24" w doors with adjustable shelves	7075	8137
	CIJ	96	20	29½	(4) 24" w standard storage drawers (4) 24" w deep storage drawers	7175	8252

specification codes example: C4S-SKU-TB

series	sku	pull
C 4 S -	-	TB black tab TC chrome tab

material/finish code example: BK CHY 805

base finish	material	finish
BK black powdercoat base SS stainless steel base	CHY cherry MPL maple OAK oak WLT walnut PLD paldao	see page 4

108" credenzas



108" credenzas

	sku	w	d	h	specifications	CHY cherry MPL maple OAK oak WLT walnut	PLD paldao
	CAH	108	20	29½	(2) 24" w doors with adjustable shelves (2) 30" w double doors with adjustable shelves	\$ 7275	\$ 8367
	CBH	108	20	29½	(2) 24" w doors with adjustable shelves (6) 30" w standard storage drawers	7425	8539
	CCH	108	20	29½	(2) 24" w doors with adjustable shelves (2) 30" w standard storage drawers (2) 30" w deep storage drawers	7275	8367
	CDH	108	20	29½	(2) 24" w doors with adjustable shelves (2) 29½" w open shelves (4) 30" w standard storage drawers	7425	8539
	CEH	108	20	29½	(2) 24" w doors with adjustable shelves (2) 29½" w open shelves (2) 30" w deep storage drawers	7275	8367

specification codes example: C4S-SKU-TB

series	sku	pull
C 4 S -	-	TB black tab TC chrome tab

material/finish code example: BK CHY 805

base finish	material	finish
BK black powdercoat base SS stainless steel base	CHY cherry MPL maple OAK oak WLT walnut PLD paldao	see page 4

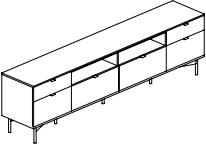
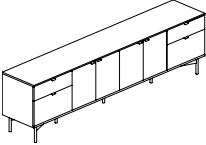

108" credenzas

	sku	w	d	h	specifications	CHY cherry MPL maple OAK oak WLT walnut	PLD paldao
	CFH	108	20	29½	(2) 24" w standard storage drawers (2) 24" w deep storage drawers (2) 29½" w open shelves (2) 30" w deep storage drawers	\$ 7425	\$ 8539
	CGH	108	20	29½	(6) 24" w standard storage drawers (2) 30" w double doors with adjustable shelves	7500	8625
	CHH	108	20	29½	(2) 24" w standard storage drawers (2) 24" w deep storage drawers (2) 30" w double doors with adjustable shelves	7425	8539
	CIH	108	20	29½	(2) 24" w standard storage drawers (2) 24" w deep storage drawers (2) 30" w standard storage drawers (2) 30" w deep storage drawers	7500	8625

specification codes example: C4S-SKU-TB

series	sku	pull
C 4 S -	-	TB black tab TC chrome tab

material/finish code example: BK CHY 805

base finish	material	finish
BK black powdercoat base SS stainless steel base	CHY cherry MPL maple OAK oak WLT walnut PLD paldao	see page 4

120" credenzas



120" credenzas

	sku	w	d	h	specifications	CHY cherry MPL maple OAK oak WLT walnut	PLD paldao
	CAF	120	20	29½	(2) 24" w doors with adjustable shelves (2) 36" w double doors with adjustable shelves	\$ 7750	\$ 8913
	CBF	120	20	29½	(2) 24" w doors with adjustable shelves (6) 36" w standard storage drawers	7900	9085
	CCF	120	20	29½	(2) 24" w doors with adjustable shelves (3) 24" w standard storage drawers (3) 24" w deep storage drawers	7750	8913
	CDF	120	20	29½	(2) 24" w doors with adjustable shelves (2) 35½" w open shelves (4) 36" w standard storage drawers	7900	9085
	CEF	120	20	29½	(2) 24" w doors with adjustable shelves (2) 35½" w open shelves (2) 36" w deep storage drawers	7750	8913

specification codes example: C4S-SKU-TB

series	sku	pull
C 4 S -	-	TB black tab TC chrome tab

material/finish code example: BK CHY 805

base finish	material	finish
BK black powdercoat base SS stainless steel base	CHY cherry MPL maple OAK oak WLT walnut PLD paldao	see page 4

120" credenzas

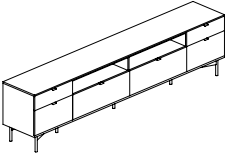
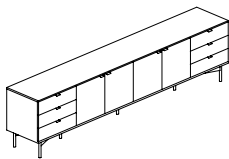
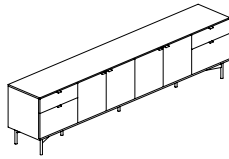
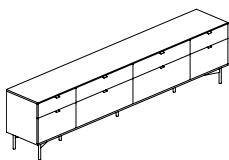

120" credenzas

	sku	w	d	h	specifications	CHY cherry MPL maple OAK oak WLT walnut	PLD paldao
	CFF	120	20	29½	(2) 24" w standard storage drawers (2) 24" w deep storage drawers (2) 35⅝" w open shelves (2) 36" w deep storage drawers	\$ 7900	\$ 9085
	CGF	120	20	29½	(6) 24" w standard storage drawers (2) 36" w double doors with adjustable shelves	8000	9200
	CHF	120	20	29½	(2) 24" w standard storage drawers (2) 24" w deep storage drawers (2) 36" w double doors with adjustable shelves	7885	9068
	CIF	120	20	29½	(2) 24" w standard storage drawers (2) 24" w deep storage drawers (2) 36" w standard storage drawers (2) 36" w deep storage drawers	8000	9200

specification codes example: C4S-SKU-TB

series	sku	pull
C 4 S -	-	TB black tab TC chrome tab

material/finish code example: BK CHY 805

base finish	material	finish
BK black powdercoat base SS stainless steel base	CHY cherry MPL maple OAK oak WLT walnut PLD paldao	see page 4



tops - glass

position the glass top 1/2" from front and sides keeping it flush with the back of the credenza
 glass will rest on the surface of the credenza wood top

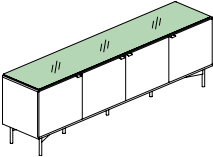

	sku	w	d	h	specifications	GPW back-painted white glass	GEW etched back-painted white glass	GEB etched back-painted black glass
	GLN	71	19½	¾	use with 72" credenza	\$ 1545	\$ 1900	\$ 2470
	GLL	83	19½	¾	use with 84" credenza	1790	2210	2865
	GLK	89	19½	¾	use with 90" credenza	1910	2360	3065
	GLJ	95	19½	¾	use with 96" credenza	2030	2510	3265
	GLH	107	19½	¾	use with 108" credenza	2275	2810	3660
	GLF	119	19½	¾	use with 120" credenza	2520	3120	4060

specification codes example: C4S-SKU

series	sku
C 4 S -	

material/finish code example: PS GPW

edge	material
PF polished flat	GPW back-painted white glass GEW etched back-painted white glass GEB etched back-painted black glass



trash/recycling bin

description	sku	w	d	h		price
	trash/recycling bin	T30	16 ⁷ / ₈	18 ¹ / ₄	17 ⁷ / ₈	\$ 800

Slideout, dual compartment trash/recycling bin
 Rack ships assembled
 Includes: (1) open-top 30 liter bin and (1) open-top 19 liter bin
 Gray LLDPE
 1" square adhesive backed trash and recycled icons
 included for optional on-site installation.



specification codes example: ACS-SKU

series	sku
A C S -	

Preferred Carrier Guaranteed Freight Rates

Freight charges will be applied to orders as a separate line item based on the zones listed. Rates are based on zones with a minimum for each zone. All zones are located within the Continental United States.

The freight amount is calculated on the total merchandise net price, excluding any extra discounts beyond standard net pricing. Additional freight fuel surcharges may apply. Rates are based on deliveries made Monday through Friday, 8 am until 5 pm.

All orders are shipped by Bernhardt Design company trucks or preferred carriers specified by Bernhardt Design. Dealer warehouse information, including phone number and contact name, must be specified on the purchase order.

Direct site deliveries may be requested with an additional freight cost. Requests for direct site deliveries must be made 2 weeks prior to the scheduled ship week and meet the following criteria:

- Minimum of half truckload
- Delivery site accessible by a 53' trailer
- Complete delivery site address with contact name and on-site phone number
- Labor available for unloading

Deliveries that do not meet the criteria must be directed to a receiver warehouse. If a receiver warehouse is not available, the dealer may make arrangements with their own 3rd party carrier. If a 3rd party carrier is elected, a contact name, phone number and e-mail address is required.

Weekend direct site deliveries will incur a \$500 per trailer weekend delivery fee. Weekend is defined as between 5 pm Friday and 8 am Monday.

Zone	Minimum Charge	Freight Rate	Average Service Days
1	\$80	5%	2-4 Business Days
2	\$80	6%	2-4 Business Days
3	\$90	7%	3-5 Business Days
4	\$90	8%	5-7 Business Days
5	\$90	9%	6-9 Business Days
6	\$110	10%	6-9 Business Days
7	\$110	11%	7-10 Business Days
8	\$120	12%	8-12 Business Days
9	\$120	13%	8-12 Business Days
10	\$120	15%	10-15 Business Days

Note: Average Service Days excludes ship day.

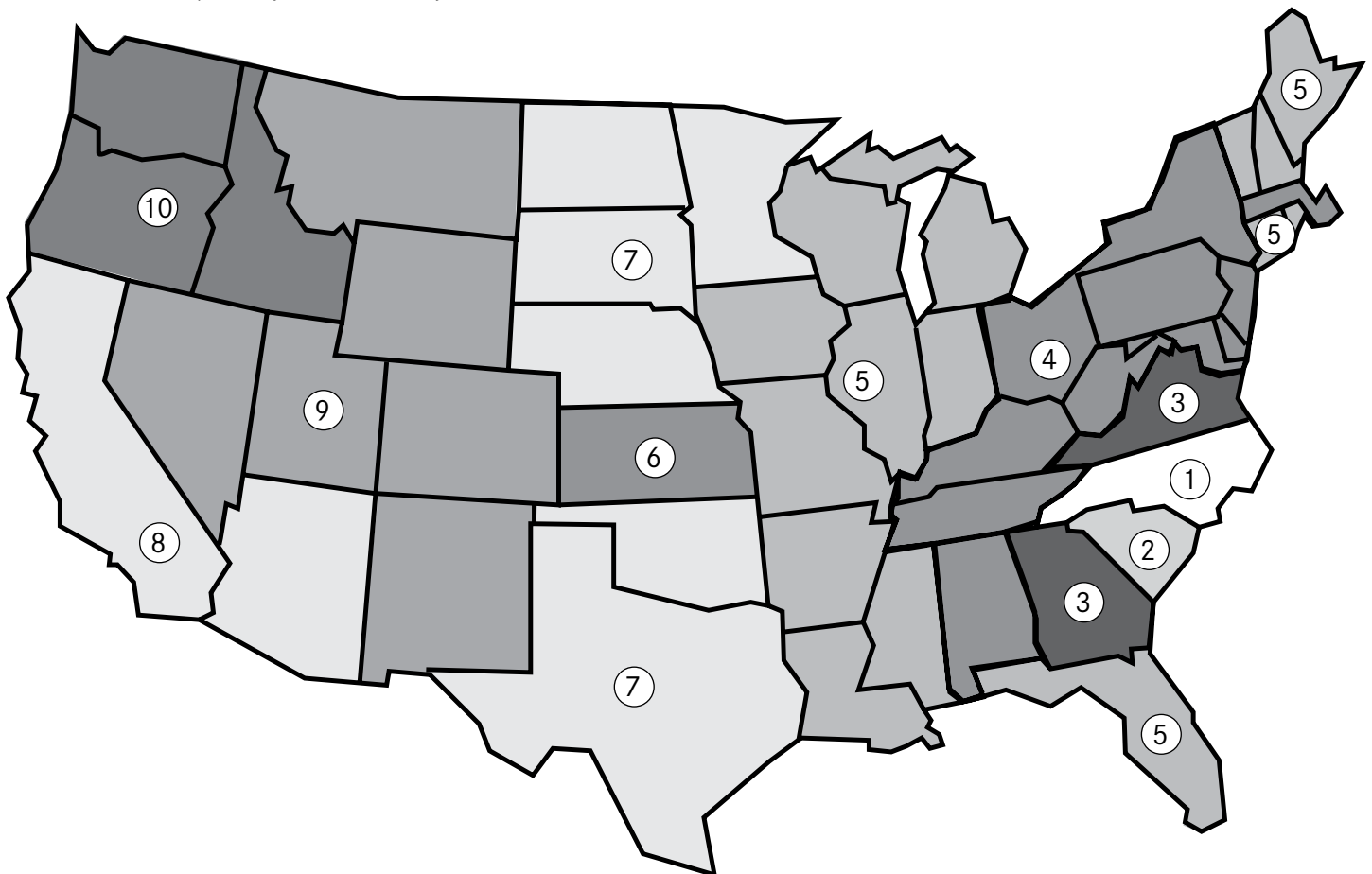

Sales and Service Policy

Guidelines detailing the operating policies and procedures of Bernhardt Design are provided in the Sales and Service Policy available online at <http://www.bernhardtdesign.com/sales-and-service-policy>.

Prices and Specifications

Prices and specifications are subject to change without notice. All prices quoted will be FOB our factories. If applicable, sales tax will be based on ship-to destination.

Bernhardt Design reserves the right to make changes in dimensions, construction, price lists, or product literature without prior notice.

Order Entry

All orders are subject to final acceptance by Bernhardt Design in Lenoir, NC. Receipt of our acknowledgment indicates acceptance of your order subject to the terms set forth on the acknowledgment. Bernhardt Design attempts to clarify all purchase orders. However, in the event the price list number and description on the purchase order differ, the price list number will prevail.

Changes / Cancellation

All orders in production are considered firm orders and are not subject to changes or cancellation.

Custom Design

Bernhardt Design may alter products to meet specific needs. Contact your local sales representative when a custom design is needed. Custom designs require minimum quantities, additional lead time, and upcharges.

A custom job number, available from your local sales representative, must be submitted with purchase orders. Orders combining custom design with standard product cannot be scheduled for production until custom items are approved. Custom design orders are not subject to revision or cancellation after acknowledgment.

Shipping

Bernhardt Design will ship in accordance with customer instructions whenever possible. If not specified, Bernhardt Design will exercise its best judgment in selecting a carrier. Orders in production will be shipped as scheduled and cannot be held.

High quality cartoning meeting trucking and railroad specifications is standard at no extra charge. Some items may be blanket wrapped for shipment.

Freight Damage and Claims

Bernhardt Design is not liable for damages that occur during transit or storage. The carrier assumes all responsibility upon acceptance of product.

It is the customer's responsibility to inspect all products upon receipt and file any claims with the carrier. No product should be refused. If products are received damaged, a written exception should be made on the bill of lading and an immediate inspection be requested of the

carrier. Concealed damage must be reported to the carrier within 10 business days from date of delivery. Failure to make claims shall constitute acceptance of the products and waiver any claims of defects, errors or shortages.

In the event delivery is made on a Bernhardt Design truck, the products should be carefully inspected for transit damage. If contents are damaged, the driver should be notified to call his dispatcher for immediate disposition. Concealed damage must be reported within 10 business days from date of delivery and product/packaging held for inspection by a Bernhardt Design representative.

Replacements for product damaged in shipment or storage will be manufactured upon receipt of a purchase order.

Returns

No merchandise may be returned to Bernhardt Design without written consent in the form of a Return Authorization from our Quality Assurance Department stating why the item is being returned and how the item will be shipped.

Unauthorized returns will be automatically refused by our receiving department as well as returns not in accordance with Bernhardt Design shipping instructions. Liability for defective merchandise shall be limited to the replacement or repair of that merchandise, and Bernhardt Design shall not be liable for other damages or losses.

Measurements and Weights

All measurements and weights are approximate and subject to change without notice.

Care and Cleaning

Finished wood surfaces should be cleaned with a soft damp cloth, wiping in the direction of the grain. Furniture should be buffed dry immediately with a soft cloth.

Wood Finishes

Bernhardt Design tables are available in finishes that are compatible with casegoods and seating finishes. However, finishes on tables may vary slightly from those on casegoods and seating due to the natural characteristics of the wood. No absolute match is implied or guaranteed.

Light Finishes

Bernhardt Design offers lighter finishes 836, 837, 840, 850, and 870 on certain veneers. Light finishes do not hide or mask the natural characteristics of the wood. Therefore, inherent natural characteristics of the wood will vary from piece to piece when using a light finish. Natural characteristics include the natural discolorations of the wood substance and color variations in glued up stock. These natural characteristics are not considered defects by Bernhardt Design, and therefore merchandise will not be replaced.

Special Finishes

Special finishes, made to customer specifications and subject to factory approval, may be available at a **5% net upcharge with a \$500 net minimum**.

Additional leadtime may be required for special finish items. Special finish orders will not be acknowledged until the special finish sample is approved in writing and received by Bernhardt Design Customer Service. Special finish orders are not subject to revision or cancellation after acknowledgment.

Installation and Maintenance

All freestanding casegoods are equipped with leveling devices. Local floor conditions vary, and it is always necessary to properly adjust leveling devices. Proper leveling is essential to the alignment and function of doors and drawers. Improperly leveled units result in misaligned doors and drawers and may impair locking mechanisms or other functional hardware.

After the initial installation of casegoods, it may be necessary to readjust and align the units to compensate for settling. This should be expected as a matter of routine maintenance and follow-up to assure proper case function.

Proper installation of Bernhardt Design casegoods is the responsibility of the dealer. Improperly installed units can result in permanent damage to case components. Damage due to improperly installed furniture not covered under product warranty.

Warranty

Bernhardt Design will repair or replace, at its discretion, any casegoods product or part thereof which fails as the result of defects in material and workmanship, under single shift use and normal care for five years. This warranty shall apply only to the original purchaser. This warranty does not cover normal wear and tear, misuse or abuse of product, dramatic temperature changes, exposure to unusual conditions or damages incurred by contact with seating products, tables, desks or other surfaces.

Natural color changes, variations or movements in lumber or veneer products, exposure to extreme temperature changes and direct sunlight may cause color changes and/or surface damage. These are circumstances beyond the control of Bernhardt Design and are not warranty issues. Repair or replacement of discontinued product will be at the discretion of Bernhardt Design.

This warranty is the customer's exclusive remedy for product defect and does not apply to damage caused by a freight carrier, dealer, installer, user modification, attachments to a product, or any third party. Bernhardt Design has the exclusive right to make the final determination of product misuse or abuse.

Except as stated above, Bernhardt Design makes no express or implied warranties as to any product, and in particular, makes no warranty of merchantability or of fitness for any particular purpose. Bernhardt Design shall not be liable for any consequential or incidental damages or for commercial loss arising from any product defect.

Operational Parts Warranty

Drawer glides, drawer boxes, drawer pulls, and lock mechanisms have a Life-Time Warranty for original purchaser. Power and communication components are warranted for one year.

Wall Mount Units Warranty

Wall mounted units are supplied with an adequate attachment device but not with hardware to attach this device to the support wall. It is the responsibility of the dealer/installer to ensure the wall structure is adequate to support the unit and that the attachment device is properly secured to the wall structure.

Design and Patent Rights

All of the products shown in Bernhardt Design catalogs and described in Bernhardt Design price lists are, and remain, the property of Bernhardt Design, with the sole right reserved to manufacture and to distribute.

Some of the product designs shown are patented in the United States and will remain the property of Bernhardt Design. Any reproduction of the products constitutes an infringement of patented copyright laws and will be subject to prosecution.

Bernhardt Design reserves the right to make changes in dimensions, design and/or construction, price lists, or product literature without prior notice.