

a.k.a. floating credenzas

february 2019 price list

index	2
collection overview	3
materials/finishes	4
hardware/ordering guide	5
tops	6-9
wall mount assemblies	10-11
wall mount pedestals	12
guaranteed freight	13
terms and conditions	14-15

A.K.A. Floating Credenzas

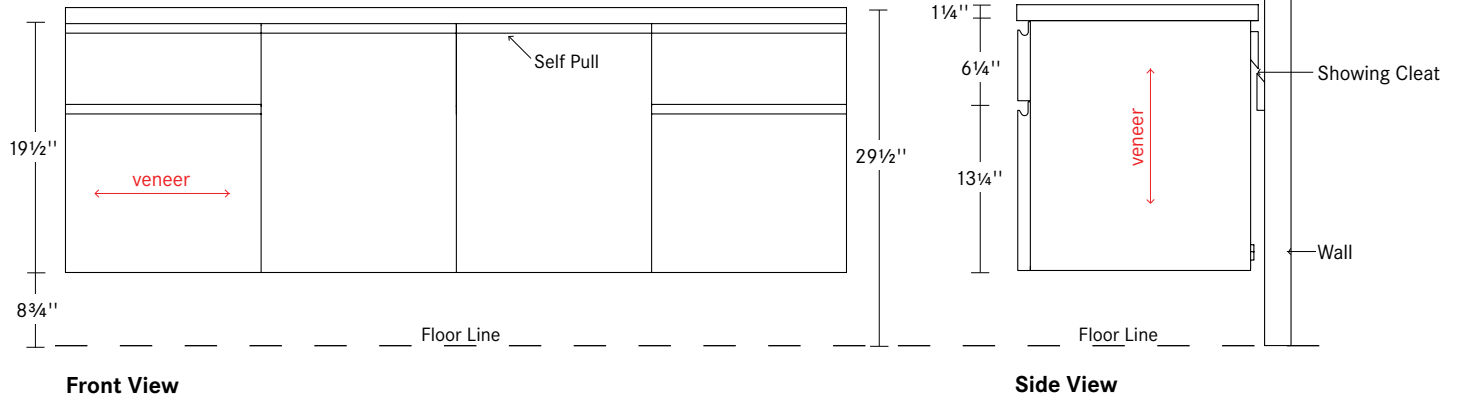

**Laminates**

**Laminate Selections**



FL 1¼" Flat Edge

A three character sku identifies each laminate selection as well as the standard finish offered. Individual components are priced with standard finish on standard laminate.

A variety of Wilsonart® standard laminates with standard finishes are offered on conference and multipurpose tables. Additional colors may be available but are subject to upcharges and extended lead times. The laminate option is available on components where noted as an option in the material specification code.

All laminate tops will have a 3mm matching edge band.

**Standard Laminates**

- PLL** Solid Laminate
- 671** Designer White, Wilsonart D354-60 Matte Finish
- 672** Frosty White, Wilsonart 1573-60 Matte Finish
- 673** Fashion Grey, Wilsonart D381-60 Matte Finish
- 674** North Sea, Wilsonart D90-60 Matte Finish
- 675** Black, Wilsonart 1595-60 Matte Finish
- WGL** Woodgrain Laminate
- 678** New Age Oak, Wilsonart 7938-16 Soft Grain Finish
- 679** Brazilwood, Wilsonart 7946-38 Matte Finish
- 680** Walnut Heights, Wilsonart 7965K-12 Soft Grain Finish
- 681** Studio Teak, Wilsonart 7960-16 Soft Grain Finish
- 682** Asian Night, Wilsonart 7949-16 Soft Grain Finish
- 683** Portico Teak (Grey), Wilsonart 8210K-28 Gloss Line Finish

**Veneers**

**Veneer Selections**

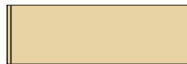

FL 1¼" Flat Edge

A three character sku identifies each species as well as the standard finish offered. Individual components are priced with standard finish. Special finishes on veneers made to customer specifications are subject to factory approval and a 5% net upcharge with a \$500 net minimum.

Transparent stains and sealers are applied in multiple steps to enhance the beauty of the natural wood. A durable, baked-on, top-coat of conversion varnish or UV topcoat is applied to protect the product. It is recommended that felt, cork or fabric backed desk pads and accessories are used on tops to minimize wear.

When specifying light finishes such as 836, 837, 840, 850 or 870, the color and characteristic variances of both veneer and solid wood are apparent. Therefore, exact color matches are not possible.

**Pedestals/Assemblies**

- CHY** Cherry
- MPL** Maple
- WLT** Walnut
- OAK** Oak
- PLD** Paldao

Flat Cut

Rift/Quarter Cut

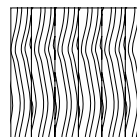
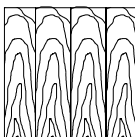

**Standard Finishes**

<b>PNT</b> Paint	<b>CHY</b> Cherry	<b>WLT</b> Walnut	<b>OAK</b> Oak
100 108	805	823	805 865
101 110	834	839	836 866
102 111	836	841	837 870
103 112	839	860	839
104 113	840	861	840
105 114	841	866	860
106 115	861	870	861
<b>MPL</b> Maple	<b>PLD</b> Paldao		
837	823 861		
850	839 866		
	841 870		
	860		

**Glass Selections - Tops**



PL 1¼" Polished Flat Edge

**GPW** Back-Painted White Glass - Top

**GEW** Etched, Back-Painted White Glass - Top

**Solid Surface Selections - Tops**

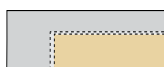

FL 1¼" Flat Edge

**SSF** Solid Surface

**Standard Finish**

**CGW** Corian, Glacier White

### Pull/Hardware Selections

---

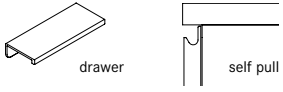

- SF** Self Pull
- AA** Brushed Aluminum
- AG** Brushed Graphite

### Ordering Guide/Product Selection Sequence

---

1. Select top size
2. Select assemblies or pedestals

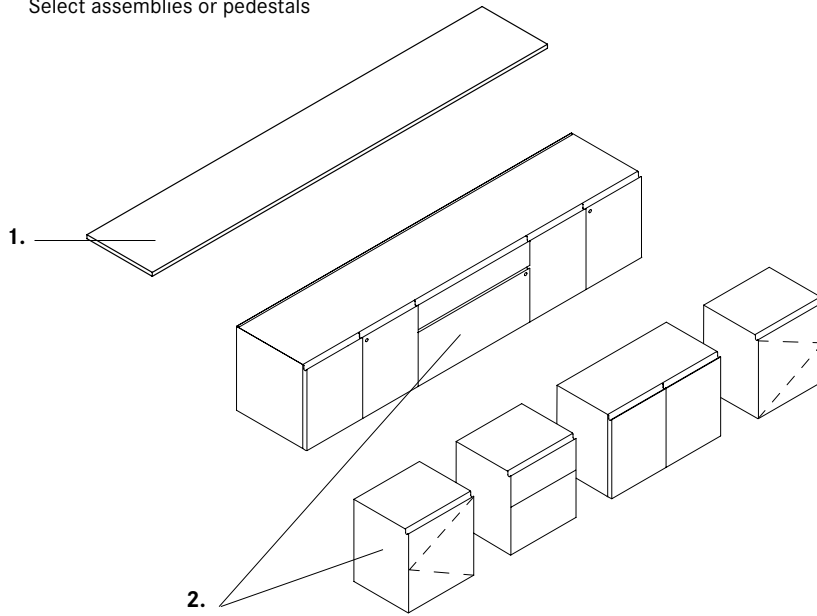

1

**tops - laminates  
for pedestals 18<sup>7</sup>/<sub>8</sub>"d**



tops - laminate for pedestals 18<sup>7</sup>/<sub>8</sub>"d

1<sup>1</sup>/<sub>4</sub>"h laminate top

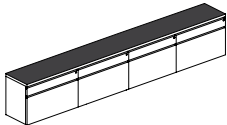

lamine top

description	sku	w	d	h	PLL solid laminate	
					WGL woodgrain laminate	
	4BV	30	18 <sup>7</sup> / <sub>8</sub>	1 <sup>1</sup> / <sub>4</sub>		\$ 368
	4BU	36	18 <sup>7</sup> / <sub>8</sub>	1 <sup>1</sup> / <sub>4</sub>		406
	4BT	42	18 <sup>7</sup> / <sub>8</sub>	1 <sup>1</sup> / <sub>4</sub>		444
	4BS	48	18 <sup>7</sup> / <sub>8</sub>	1 <sup>1</sup> / <sub>4</sub>		482
	4BR	54	18 <sup>7</sup> / <sub>8</sub>	1 <sup>1</sup> / <sub>4</sub>		520
	4BQ	60	18 <sup>7</sup> / <sub>8</sub>	1 <sup>1</sup> / <sub>4</sub>		557
	4BP	66	18 <sup>7</sup> / <sub>8</sub>	1 <sup>1</sup> / <sub>4</sub>		595
	4BN	72	18 <sup>7</sup> / <sub>8</sub>	1 <sup>1</sup> / <sub>4</sub>		633
	4BM	78	18 <sup>7</sup> / <sub>8</sub>	1 <sup>1</sup> / <sub>4</sub>		670
	4BL	84	18 <sup>7</sup> / <sub>8</sub>	1 <sup>1</sup> / <sub>4</sub>		708
	4BK	90	18 <sup>7</sup> / <sub>8</sub>	1 <sup>1</sup> / <sub>4</sub>		746
	4BJ	96	18 <sup>7</sup> / <sub>8</sub>	1 <sup>1</sup> / <sub>4</sub>		784
	4BI	102	18 <sup>7</sup> / <sub>8</sub>	1 <sup>1</sup> / <sub>4</sub>		821
	4BH	108	18 <sup>7</sup> / <sub>8</sub>	1 <sup>1</sup> / <sub>4</sub>		859
	4BG	114	18 <sup>7</sup> / <sub>8</sub>	1 <sup>1</sup> / <sub>4</sub>		897
	4BF	120	18 <sup>7</sup> / <sub>8</sub>	1 <sup>1</sup> / <sub>4</sub>		934

specification codes example: AKS-SKU-FL

series	sku	edge
a.k.a.		FL 1 <sup>1</sup> / <sub>4</sub> " flat
A   K   S   -	-	F   L

material/finish code example: PLL 671

material	finish
PLL solid laminate WGL woodgrain laminate	see page 4

**tops - veneer  
for pedestals 18<sup>7</sup>/<sub>8</sub>"d**



**tops - veneer for pedestals 18<sup>7</sup>/<sub>8</sub>"d**

1<sup>1</sup>/<sub>4</sub>"h veneer top

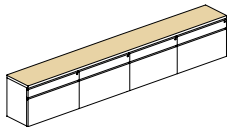

**veneer top**

description	sku	w	d	h	CHY cherry	MPL maple	PLD paldao
					OAK oak	WLT walnut	
					\$ 755	\$ 876	
					811	941	
					868	1007	
					929	1078	
					986	1144	
					1041	1208	
					1099	1275	
					1154	1339	
					1211	1405	
					1271	1475	
					1329	1542	
					1385	1607	
					1536	1782	
					1593	1848	
					1660	1926	
					1717	1992	

specification codes example: AKS-SKU-FL

series	sku	edge
a.k.a.		FL 1 <sup>1</sup> / <sub>4</sub> " flat
A   K   S   -	-	F   L

material/finish code example: WLT 839

material	finish
CHY cherry	see page 4
MPL maple	
OAK oak	
WLT walnut	
PLD paldao	

**tops - glass  
for pedestals 18<sup>7</sup>/<sub>8</sub>"d**



**tops - glass for pedestals 18<sup>7</sup>/<sub>8</sub>"d**

1/2" glass top has veneer edge band subtop construction  
specify material code GPW or GEW  
specify subtop and subtop finish code

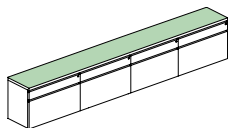
description	sku	w	d	h	GPW	GEW etched
					back-painted white glass	back-painted white glass
 <b>glass top</b>	4BV	30	18 <sup>7</sup> / <sub>8</sub>	1 <sup>1</sup> / <sub>4</sub>	\$ 2273	\$ 2774
	4BU	36	18 <sup>7</sup> / <sub>8</sub>	1 <sup>1</sup> / <sub>4</sub>	2362	2882
	4BT	42	18 <sup>7</sup> / <sub>8</sub>	1 <sup>1</sup> / <sub>4</sub>	2475	3020
	4BS	48	18 <sup>7</sup> / <sub>8</sub>	1 <sup>1</sup> / <sub>4</sub>	2600	3172
	4BR	54	18 <sup>7</sup> / <sub>8</sub>	1 <sup>1</sup> / <sub>4</sub>	2723	3323
	4BQ	60	18 <sup>7</sup> / <sub>8</sub>	1 <sup>1</sup> / <sub>4</sub>	2858	3487
	4BP	66	18 <sup>7</sup> / <sub>8</sub>	1 <sup>1</sup> / <sub>4</sub>	3005	3667
	4BN	72	18 <sup>7</sup> / <sub>8</sub>	1 <sup>1</sup> / <sub>4</sub>	3127	3815
	4BM	78	18 <sup>7</sup> / <sub>8</sub>	1 <sup>1</sup> / <sub>4</sub>	3274	3995
	4BL	84	18 <sup>7</sup> / <sub>8</sub>	1 <sup>1</sup> / <sub>4</sub>	3408	4158
	4BK	90	18 <sup>7</sup> / <sub>8</sub>	1 <sup>1</sup> / <sub>4</sub>	3521	4296
	4BJ	96	18 <sup>7</sup> / <sub>8</sub>	1 <sup>1</sup> / <sub>4</sub>	3712	4529
	4BI	102	18 <sup>7</sup> / <sub>8</sub>	1 <sup>1</sup> / <sub>4</sub>	3858	4707
	4BH	108	18 <sup>7</sup> / <sub>8</sub>	1 <sup>1</sup> / <sub>4</sub>	3994	4873
	4BG	114	18 <sup>7</sup> / <sub>8</sub>	1 <sup>1</sup> / <sub>4</sub>	4140	5051
4BF	120	18 <sup>7</sup> / <sub>8</sub>	1 <sup>1</sup> / <sub>4</sub>	4286	5229	

specification codes example: AKS-SKU-PL

series	sku	edge
a.k.a.		PL 1 1/4" polished flat
A   K   S   -	-	P   L

material/finish code example: GPW CHT 805

material	subtop	subtop finish
GPW glass back-painted white GEW glass etched back-painted white	PNT paint CHY cherry MPL maple OAK oak WLT walnut PLD paldao	see page 4



**tops - solid surface  
for pedestals 18<sup>7</sup>/<sub>8</sub>"d**



**tops - solid surface for pedestals 18<sup>7</sup>/<sub>8</sub>"d**

1<sup>1</sup>/<sub>4</sub>"h solid surface tops

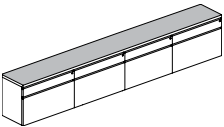
description	sku	w	d	h	SSF solid surface
 <b>solid surface top</b>	4BV	30	18 <sup>7</sup> / <sub>8</sub>	1 <sup>1</sup> / <sub>4</sub>	\$ 1407
	4BU	36	18 <sup>7</sup> / <sub>8</sub>	1 <sup>1</sup> / <sub>4</sub>	1497
	4BT	42	18 <sup>7</sup> / <sub>8</sub>	1 <sup>1</sup> / <sub>4</sub>	1598
	4BS	48	18 <sup>7</sup> / <sub>8</sub>	1 <sup>1</sup> / <sub>4</sub>	1705
	4BR	54	18 <sup>7</sup> / <sub>8</sub>	1 <sup>1</sup> / <sub>4</sub>	1846
	4BQ	60	18 <sup>7</sup> / <sub>8</sub>	1 <sup>1</sup> / <sub>4</sub>	1981
	4BP	66	18 <sup>7</sup> / <sub>8</sub>	1 <sup>1</sup> / <sub>4</sub>	2105
	4BN	72	18 <sup>7</sup> / <sub>8</sub>	1 <sup>1</sup> / <sub>4</sub>	2239
	4BM	78	18 <sup>7</sup> / <sub>8</sub>	1 <sup>1</sup> / <sub>4</sub>	2508
	4BL	84	18 <sup>7</sup> / <sub>8</sub>	1 <sup>1</sup> / <sub>4</sub>	2644
	4BK	90	18 <sup>7</sup> / <sub>8</sub>	1 <sup>1</sup> / <sub>4</sub>	2780
	4BJ	96	18 <sup>7</sup> / <sub>8</sub>	1 <sup>1</sup> / <sub>4</sub>	2914
	4BI	102	18 <sup>7</sup> / <sub>8</sub>	1 <sup>1</sup> / <sub>4</sub>	3037
	4BH	108	18 <sup>7</sup> / <sub>8</sub>	1 <sup>1</sup> / <sub>4</sub>	3161
	4BG	114	18 <sup>7</sup> / <sub>8</sub>	1 <sup>1</sup> / <sub>4</sub>	3296
4BF	120	18 <sup>7</sup> / <sub>8</sub>	1 <sup>1</sup> / <sub>4</sub>	3387	

specification codes example: AKS-SKU-FL

series	sku	edge
a.k.a.		FL 1 <sup>1</sup> / <sub>4</sub> " flat
A   K   S   -	-	F   L

material/finish code example: SSF CGW

material	finish
SSF solid surface	CGW glacier white
S   S   F	C   G   W



**wall mount assemblies**

designed to mount on drywall, cleat included on each cabinet  
specify top separately

description	sku	w	d	h	specifications	PNT	CHY	MPL	OAK	WLT	PLD	paldao
						paint	cherry	maple	oak	walnut		
<b>door assemblies</b> 1 adjustable shelf	CDP	60	18 <sup>7</sup> / <sub>8</sub>	19 <sup>1</sup> / <sub>2</sub>	(2) 30" DD		\$ 3656					\$ 4241
	CDQ	72	18 <sup>7</sup> / <sub>8</sub>	19 <sup>1</sup> / <sub>2</sub>	(2) 36" DD			3758				4360
	CLT	90	18 <sup>7</sup> / <sub>8</sub>	19 <sup>1</sup> / <sub>2</sub>	(3) 30" DD			5489				6368
	CLU	108	18 <sup>7</sup> / <sub>8</sub>	19 <sup>1</sup> / <sub>2</sub>	(3) 36" DD			5635				6537

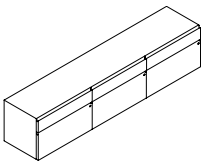
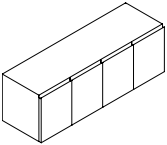

**drawer assemblies**

CFP	60	18 <sup>7</sup> / <sub>8</sub>	19 <sup>1</sup> / <sub>2</sub>	(2) 30" BF		4410	5116
CFQ	72	18 <sup>7</sup> / <sub>8</sub>	19 <sup>1</sup> / <sub>2</sub>	(2) 36" BF		4522	5246
CPT	90	18 <sup>7</sup> / <sub>8</sub>	19 <sup>1</sup> / <sub>2</sub>	(3) 30" BF		6609	7667
CPU	108	18 <sup>7</sup> / <sub>8</sub>	19 <sup>1</sup> / <sub>2</sub>	(3) 36" BF		6782	7868

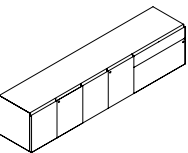

**door/drawer assemblies**

CEP	60	18 <sup>7</sup> / <sub>8</sub>	19 <sup>1</sup> / <sub>2</sub>	(1) 30" DD, (1) 30" BF		4134	4796
CEQ	72	18 <sup>7</sup> / <sub>8</sub>	19 <sup>1</sup> / <sub>2</sub>	(1) 36" DD, (1) 36" BF		4257	4939
CST	90	18 <sup>7</sup> / <sub>8</sub>	19 <sup>1</sup> / <sub>2</sub>	(1) 30" DD, (2) 30" BF		6411	7437
CSU	108	18 <sup>7</sup> / <sub>8</sub>	19 <sup>1</sup> / <sub>2</sub>	(1) 36" DD, (2) 36" BF		6580	7633
CNS	90	18 <sup>7</sup> / <sub>8</sub>	19 <sup>1</sup> / <sub>2</sub>	(2) 30" DD, (1) 30" BF		6243	7242
CMS	108	18 <sup>7</sup> / <sub>8</sub>	19 <sup>1</sup> / <sub>2</sub>	(2) 36" DD, (1) 36" BF		6411	7437

specification codes example: AKS-SKU-SF

series	sku	pull
a.k.a.		SF self pull AA brushed aluminum AG brushed graphite
A   K   S   -	-	

material/finish code example: WLT 839

material	finish
PNT paint CHY cherry MPL maple OAK oak WLT walnut PLD paldao	see page 4



**wall mount assemblies**

designed to mount on drywall, cleat included on each cabinet  
specify top separately

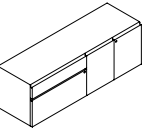
description	sku	w	d	h	specifications	PNT	CHY	MPL	OAK	WLT	PLD	paldao
						paint	cherry	maple	oak	walnut		
 <p><b>drawer/door assemblies</b> 1 adjustable shelf</p>	CGP	60	18 $\frac{7}{8}$	19 $\frac{1}{2}$	(1) 30" BF, (1) 30" DD						4134	4796
	CGQ	72	18 $\frac{7}{8}$	19 $\frac{1}{2}$	(1) 36" BF, (1) 36" DD						4257	4939
	CQT	90	18 $\frac{7}{8}$	19 $\frac{1}{2}$	(2) 30" BF, (1) 30" DD						6411	7437
	CQU	108	18 $\frac{7}{8}$	19 $\frac{1}{2}$	(2) 36" BF, (1) 36" DD						6580	7633
	COT	90	18 $\frac{7}{8}$	19 $\frac{1}{2}$	(1) 30" BF, (2) 30" DD						6243	7242
	COU	108	18 $\frac{7}{8}$	19 $\frac{1}{2}$	(1) 36" BF, (2) 36" DD						6411	7437

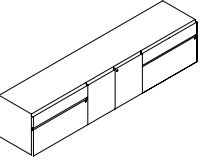
 <p><b>drawer/door drawer assemblies</b> 1 adjustable shelf</p>	CRT	90	18 $\frac{7}{8}$	19 $\frac{1}{2}$	(2) 30" BF, (1) 30" DD						6411	7437
	CRU	108	18 $\frac{7}{8}$	19 $\frac{1}{2}$	(2) 36" BF, (1) 36" DD						6580	7633

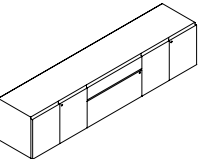
 <p><b>door/drawer drawer assemblies</b> 1 adjustable shelf</p>	CNR	90	18 $\frac{7}{8}$	19 $\frac{1}{2}$	(2) 30" DD, (1) 30" BF						6243	7242
	CMR	108	18 $\frac{7}{8}$	19 $\frac{1}{2}$	(2) 36" DD, (1) 36" BF						6411	7437

specification codes example: AKS-SKU-SF

series	sku	pull
a.k.a.		SF self pull AA brushed aluminum AG brushed graphite
A   K   S   -	-	

material/finish code example: WLT 839

material	finish
PNT paint CHY cherry MPL maple OAK oak WLT walnut PLD paldao	see page 4

**wall mount  
pedestals**



**wall mount pedestals**

designed to mount on drywall, cleat included on each cabinet  
specify top separately

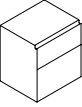
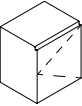
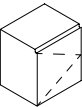
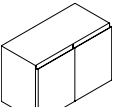
description	sku	w	d	h	specifications	PNT paint		CHY cherry		MPL maple		OAK oak		WLT walnut		PLD paldao			
 <b>floating pedestal box/file drawer</b>	FJR	18	18 <sup>7</sup> / <sub>8</sub>	19 <sup>1</sup> / <sub>2</sub>													\$ 1738	\$ 2017	
	FJM	30	18 <sup>7</sup> / <sub>8</sub>	19 <sup>1</sup> / <sub>2</sub>														2106	2443
	FJK	36	18 <sup>7</sup> / <sub>8</sub>	19 <sup>1</sup> / <sub>2</sub>															2154
 <b>floating pedestal single door</b>  hinged left 1 adjustable shelf	FDR	18	18 <sup>7</sup> / <sub>8</sub>	19 <sup>1</sup> / <sub>2</sub>														1407	1633
 <b>floating pedestal single door</b>  hinged right 1 adjustable shelf	FFR	18	18 <sup>7</sup> / <sub>8</sub>	19 <sup>1</sup> / <sub>2</sub>														1407	1633
 <b>floating cabinet double doors</b>  1 adjustable shelf	FDM	30	18 <sup>7</sup> / <sub>8</sub>	19 <sup>1</sup> / <sub>2</sub>	(1) 30" DD													1832	2126
	FDK	36	18 <sup>7</sup> / <sub>8</sub>	19 <sup>1</sup> / <sub>2</sub>	(1) 36" DD														1877

specification codes example: AKS-SKU-SF

series	sku	pull
a.k.a.		SF self pull AA brushed aluminum AG brushed graphite
A   K   S   -	-	

material/finish code example: WLT 839

material	finish
PNT paint CHY cherry MPL maple OAK oak WLT walnut PLD paldao	see page 4

**Preferred Carrier Guaranteed Freight Rates**

Freight charges will be applied to orders as a separate line item based on the zones listed. Rates are based on zones with a minimum for each zone. All zones are located within the Continental United States.

The freight amount is calculated on the total merchandise net price, excluding any extra discounts beyond standard net pricing. Additional freight fuel surcharges may apply. Rates are based on deliveries made Monday through Friday, 8 am until 5 pm.

All orders are shipped by Bernhardt Design company trucks or preferred carriers specified by Bernhardt Design. **If a purchase order does not specify that the product must ship complete, Bernhardt Design reserves the right to select the most effective shipping method necessary, including split shipments.** Dealer warehouse information, including phone number and contact name, must be specified on the purchase order.

Direct site deliveries may be requested with an additional freight cost. Requests for direct site deliveries must be made 2 weeks prior to the scheduled ship week and meet the following criteria:

- Minimum of half truckload
- Delivery site accessible by a 53' trailer
- Complete delivery site address with contact name and on-site phone number
- Labor available for unloading

Deliveries that do not meet the criteria must be directed to a receiver warehouse. If a receiver warehouse is not available, the dealer may make arrangements with their own 3rd party carrier. If a 3rd party carrier is elected, a contact name, phone number and e-mail address is required.

Weekend direct site deliveries will incur a \$500 per trailer weekend delivery fee. Weekend is defined as between 5 pm Friday and 8 am Monday.

Zone	Minimum Charge	Freight Rate
1	\$80	5%
2	\$80	6%
3	\$90	7%
4	\$90	8%
5	\$90	9%
6	\$110	10%
7	\$110	11%
8	\$120	12%
9	\$120	13%
10	\$120	15%

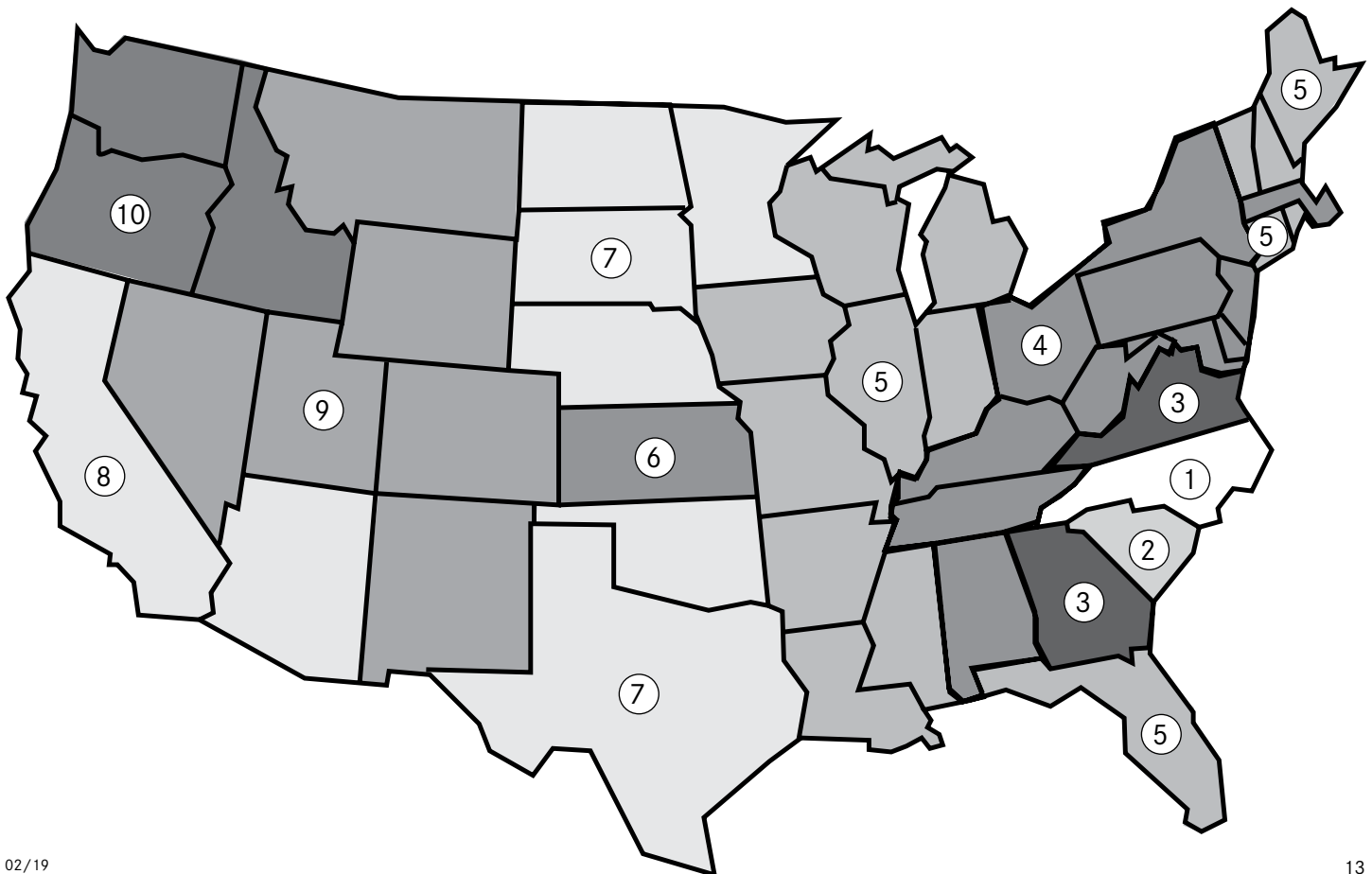

**Sales and Service Policy**

Guidelines detailing the operating policies and procedures of Bernhardt Design are provided in the Sales and Service Policy available online at <http://www.bernhardtdesign.com/sales-and-service-policy>.

**Prices and Specifications**

Prices and specifications are subject to change without notice. All prices quoted will be FOB our factories. If applicable, sales tax will be based on ship-to destination.

Bernhardt Design reserves the right to make changes in dimensions, construction, price lists, or product literature without prior notice.

**Order Entry**

All orders are subject to final acceptance by Bernhardt Design in Lenoir, NC. Receipt of our acknowledgment indicates acceptance of your order subject to the terms set forth on the acknowledgment. Bernhardt Design attempts to clarify all purchase orders. However, in the event the price list number and description on the purchase order differ, the price list number will prevail.

**Changes / Cancellation**

All orders in production are considered firm orders and are not subject to changes or cancellation.

**Custom Design**

Bernhardt Design may alter products to meet specific needs. Contact your local sales representative when a custom design is needed. Custom designs require minimum quantities, additional lead time, and upcharges.

A custom job number, available from your local sales representative, must be submitted with purchase orders. Orders combining custom design with standard product cannot be scheduled for production until custom items are approved. Custom design orders are not subject to revision or cancellation after acknowledgment.

**Shipping**

Bernhardt Design will ship in accordance with customer instructions whenever possible. If not specified, Bernhardt Design will exercise its best judgment in selecting a carrier. When selecting a carrier, Bernhardt Design will make our best effort to meet requested delivery dates. Transportation lead-times and delays including equipment problems, weather, general traffic, traffic accidents, customer warehouse space, labor disputes, customer changes etc., that occur on a carrier will not be the responsibility of Bernhardt Design. Furthermore, Bernhardt Design will not be responsible for additional costs incurred due to aforementioned delays.

Customer orders in production will be shipped as scheduled and will not be held. Bernhardt Design reserves the right to make partial shipments on any order, unless notified otherwise by the customer.

High quality cartoning meeting trucking and railroad specifications is standard at no extra charge. Some items may be blanket wrapped for shipment.

**Freight Damage and Claims**

Bernhardt Design is not liable for damages that occur during transit or storage. The carrier assumes all responsibility upon acceptance of product. It is the customer's responsibility to inspect all products upon receipt and file any claims with the carrier. No product should be refused.

If products are received damaged, a written exception should be made on the bill of lading and an immediate inspection be requested of the carrier. Concealed damage must be reported to the carrier within 10

business days from date of delivery. Failure to make claims shall constitute acceptance of the products and waiver any claims of defects, errors or shortages.

In the event delivery is made on a Bernhardt Design truck, the products should be carefully inspected for transit damage. If contents are damaged, the driver should be notified to call his dispatcher for immediate disposition. Concealed damage must be reported within 10 business days from date of delivery and product/packaging held for inspection by a Bernhardt Design representative.

Replacements for product damaged in shipment or storage will be manufactured upon receipt of a purchase order.

**Returns**

No merchandise may be returned to Bernhardt Design without written consent in the form of a Return Authorization from our Quality Assurance Department stating why the item is being returned and how the item will be shipped.

Unauthorized returns will be automatically refused by our receiving department as well as returns not in accordance with Bernhardt Design shipping instructions. Liability for defective merchandise shall be limited to the replacement or repair of that merchandise, and Bernhardt Design shall not be liable for other damages or losses.

**Measurements and Weights**

All measurements and weights are approximate and subject to change without notice.

**Care and Cleaning**

Finished wood surfaces should be cleaned with a soft damp cloth, wiping in the direction of the grain. Furniture should be buffed dry immediately with a soft cloth.

**Wood Finishes**

Bernhardt Design tables are available in finishes that are compatible with casegoods and seating finishes. However, finishes on tables may vary slightly from those on casegoods and seating due to the natural characteristics of the wood. No absolute match is implied or guaranteed.

**Light Finishes**

Bernhardt Design offers lighter finishes 836, 837, 840, 850, and 870 on certain veneers. Light finishes do not hide or mask the natural characteristics of the wood. Therefore, inherent natural characteristics

of the wood will vary from piece to piece when using a light finish. Natural characteristics include the natural discolorations of the wood substance and color variations in glued up stock. These natural characteristics are not considered defects by Bernhardt Design, and therefore merchandise will not be replaced.

#### **Special Finishes**

Special finishes, made to customer specifications and subject to factory approval, may be available at a **5% net upcharge with a \$500 net minimum.**

Additional leadtime may be required for special finish items. Special finish orders will not be acknowledged until the special finish sample is approved in writing and received by Bernhardt Design Customer Service. Special finish orders are not subject to revision or cancellation after acknowledgment.

#### **Installation and Maintenance**

All freestanding casegoods are equipped with leveling devices. Local floor conditions vary, and it is always necessary to properly adjust leveling devices. Proper leveling is essential to the alignment and function of doors and drawers. Improperly leveled units result in misaligned doors and drawers and may impair locking mechanisms or other functional hardware.

After the initial installation of casegoods, it may be necessary to readjust and align the units to compensate for settling. This should be expected as a matter of routine maintenance and follow-up to assure proper case function.

Proper installation of Bernhardt Design casegoods is the responsibility of the dealer. Improperly installed units can result in permanent damage to case components. Damage due to improperly installed furniture not covered under product warranty.

#### **Warranty**

Bernhardt Design will repair or replace, at its discretion, any casegoods product or part thereof which fails as the result of defects in material and workmanship, under single shift use and normal care for five years. This warranty shall apply only to the original purchaser. This warranty does not cover normal wear and tear, misuse or abuse of product, dramatic temperature changes, exposure to unusual conditions or damages incurred by contact with seating products, tables, desks or other surfaces.

Natural color changes, variations or movements in lumber or veneer products, exposure to extreme temperature changes and direct sunlight may cause color changes and/or surface damage. These are circumstances beyond the control of Bernhardt Design and are not warranty issues. Repair or replacement of discontinued product will be at the discretion of Bernhardt Design.

This warranty is the customer's exclusive remedy for product defect and does not apply to damage caused by a freight carrier, dealer, installer, user modification, attachments to a product, or any third party. Bernhardt Design has the exclusive right to make the final determination of product misuse or abuse.

Except as stated above, Bernhardt Design makes no express or implied warranties as to any product, and in particular, makes no warranty of merchantability or of fitness for any particular purpose. Bernhardt Design shall not be liable for any consequential or incidental damages or for commercial loss arising from any product defect.

#### **Operational Parts Warranty**

Drawer glides, drawer boxes, drawer pulls, and lock mechanisms have a Life-Time Warranty for original purchaser. Power and communication components are warranted for one year.

#### **Wall Mount Units Warranty**

Wall mounted units are supplied with an adequate attachment device but not with hardware to attach this device to the support wall. It is the responsibility of the dealer/installer to ensure the wall structure is adequate to support the unit and that the attachment device is properly secured to the wall structure.

#### **Design and Patent Rights**

All of the products shown in Bernhardt Design catalogs and described in Bernhardt Design price lists are, and remain, the property of Bernhardt Design, with the sole right reserved to manufacture and to distribute.

Some of the product designs shown are patented in the United States and will remain the property of Bernhardt Design. Any reproduction of the products constitutes an infringement of patented copyright laws and will be subject to prosecution.